

Vassiliev Invariants

(Knot parametrization)

Part I

Evert Stenlund

3₁:

$$v_{\text{even}} = x_{3.1}$$

$$v_{\text{odd}} = \pm y_{3.1}$$

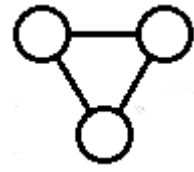
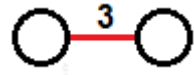
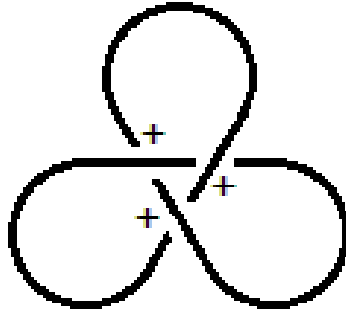

v_2	$x_{3.1}$
v_3	$\pm y_{3.1}$
v_4	$x_{3.1}$
v_5	$\pm y_{3.1}$
v_6	$x_{3.1}$

4_1 :

$$v_{\text{even}} = x_{4.1}$$

$$v_{\text{odd}} = 0$$

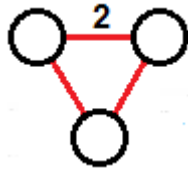
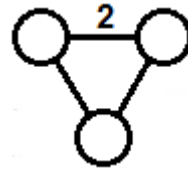
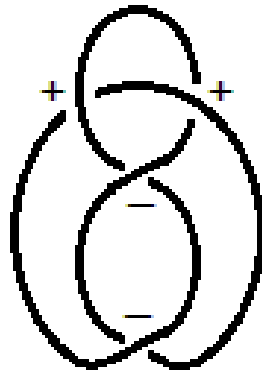

v_2	$-x_{3.1}$
v_3	0
v_4	$x_{4.1}$
v_5	0
v_6	$x_{4.1}$

5₁:

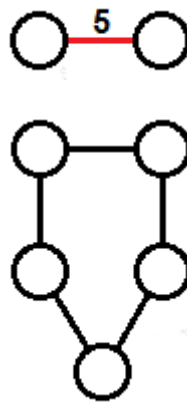
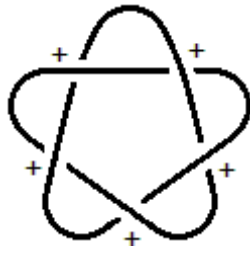

$$v_{even} = x_{5.1}$$

$$v_{odd} = \pm y_{5.1}$$

v_2	$3x_{3.1}$
v_3	$\pm 5y_{3.1}$
v_4	$x_{5.1}$
v_5	$\pm y_{5.1}$
v_6	$x_{5.1}$

5₂:

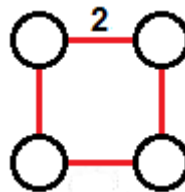
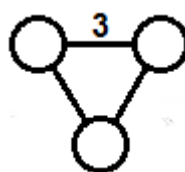
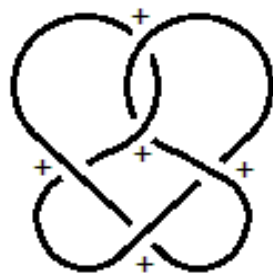

$$v_{\text{even}} = x_{5.2}$$

$$v_{\text{odd}} = \pm y_{5.2}$$

v_2	$2x_{3.1}$
v_3	$\pm 3y_{3.1}$
v_4	$x_{5.2}$
v_5	$\pm y_{5.2}$
v_6	$x_{5.2}$

6₁:

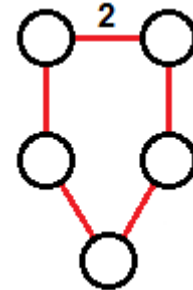
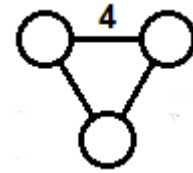
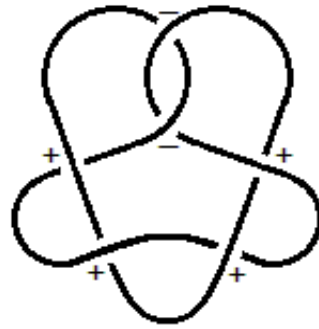

$$v_{\text{even}} = x_{6.1}$$

$$v_{\text{odd}} = \pm y_{6.1}$$

v_2	$-2x_{3.1}$
v_3	$\bar{\mp}y_{3.1}$
v_4	$-x_{5.2} + 4x_{4.1} + 4x_{3.1}$
v_5	$\pm y_{6.1}$
v_6	$x_{6.1}$

6₂:

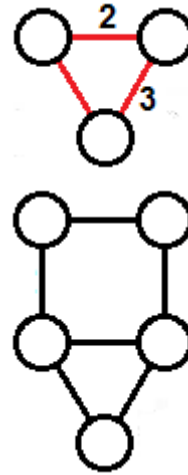
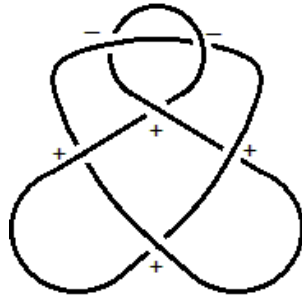

$$v_{\text{even}} = x_{6.2}$$

$$v_{\text{odd}} = \pm y_{6.2}$$

v_2	$-x_{3.1}$
v_3	$\bar{+}y_{3.1}$
v_4	$x_{5.2} - x_{5.1} + 3x_{4.1} + 3x_{3.1}$
v_5	$\pm y_{6.2}$
v_6	$x_{6.2}$

6₃:

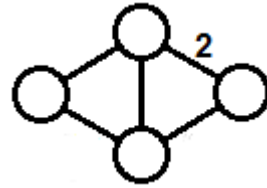
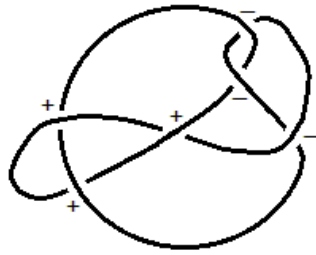

$$v_{\text{even}} = x_{6.3}$$

$$v_{\text{odd}} = 0$$

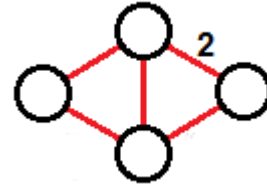

v_2	$x_{3.1}$
v_3	0
v_4	$-2x_{5.2} + x_{5.1} - x_{4.1} + x_{3.1}$
v_5	0
v_6	$x_{6.3}$

6_{3.1}#3.1:

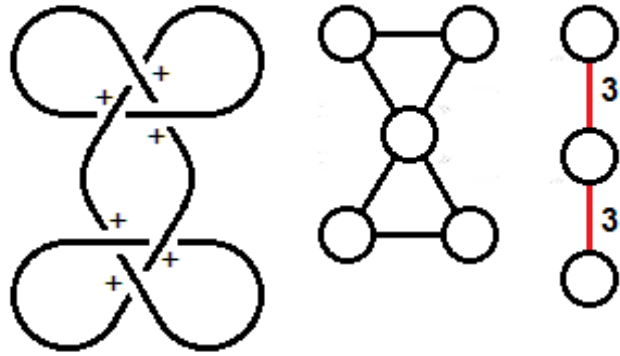

$$v_{\text{even}} = x_{3\#3}$$

$$v_{\text{odd}} = y_{3\#3}$$

v_2	$2x_{3.1}$
v_3	$\pm 2y_{3.1}$
v_4	$-3x_{5.2} + x_{5.1} + x_{4.1} + 6x_{3.1}$
v_5	$\mp(2y_{6.2} - 4y_{6.1} + 2y_{5.2} - 10y_{3.1})$
v_6	$\frac{1}{8}(-20x_{7.7} + 35x_{7.6} - 10x_{7.5} + 8x_{7.3} - 13x_{7.2} + 19x_{6.3} - 33x_{6.2} + 22x_{6.1} - 38x_{5.2} + 15x_{5.1} + 7x_{4.1} + 30x_{3.1})$

$6_{3.1\#\overline{3.1}}$:

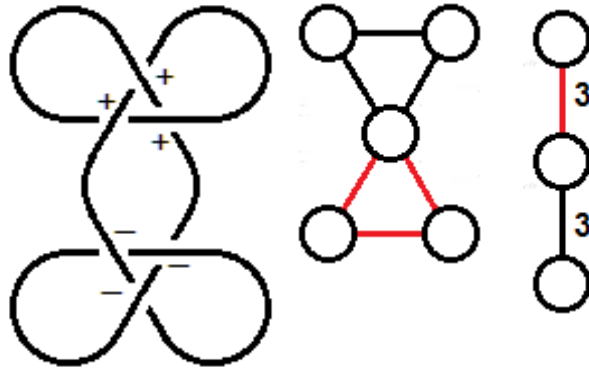

$v_{even} = x_{3\#\overline{3}}$

$v_{odd} = 0$

v_2	$2x_{3.1}$
v_3	0
v_4	$-3x_{5.2} + x_{5.1} + x_{4.1} + 6x_{3.1}$
v_5	0
v_6	$\frac{1}{8}(-36x_{7.7} + 3x_{7.6} - 10x_{7.5} + 8x_{7.3} + 3x_{7.2} + 19x_{6.3} - 33x_{6.2} + 6x_{6.1} - 54x_{5.2} - x_{5.1} + 87x_{4.1} + 126x_{3.1})$

7₁:

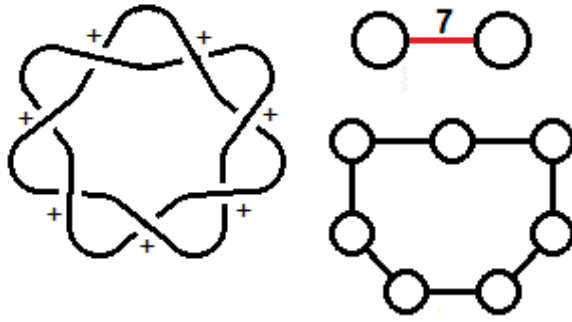

$$v_{\text{even}} = x_{7.1}$$

$$v_{\text{odd}} = \pm y_{7.1}$$

v_2	$6x_{3.1}$
v_3	$\pm 14y_{3.1}$
v_4	$5x_{5.1} - 9x_{3.1}$
v_5	$\pm(7y_{5.1} - 21y_{3.1})$
v_6	$x_{7.1}$

7₂:

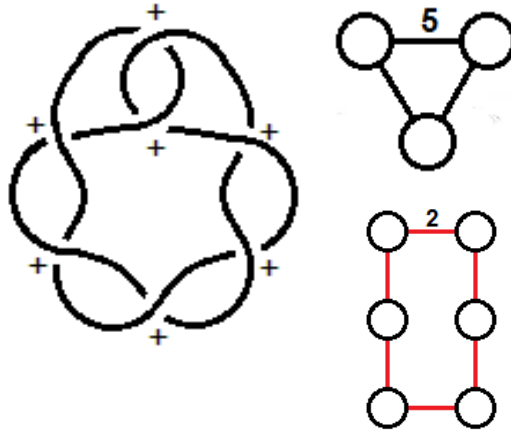

$$v_{\text{even}} = x_{7.2}$$

$$v_{\text{odd}} = \pm y_{7.2}$$

v_2	$3x_{3.1}$
v_3	$\pm 6y_{3.1}$
v_4	$4x_{5.2} - x_{4.1} - 6x_{3.1}$
v_5	$\mp(y_{6.1} - 5y_{5.2} + 10y_{3.1})$
v_6	$x_{7.2}$

7₃:

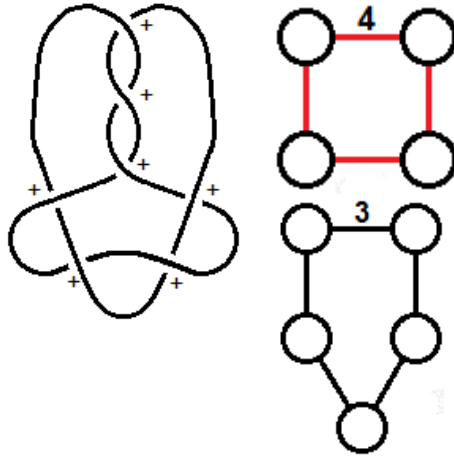

$$v_{\text{even}} = x_{7.3}$$

$$v_{\text{odd}} = \pm y_{7.3}$$

v_2	$5x_{3.1}$
v_3	$\pm 11y_{3.1}$
v_4	$3x_{5.2} + 2x_{5.1} + x_{4.1} - 6x_{3.1}$
v_5	$\pm(y_{6.2} + 4y_{5.2} + 3y_{5.1} - 15y_{3.1})$
v_6	$x_{7.3}$

7₄:

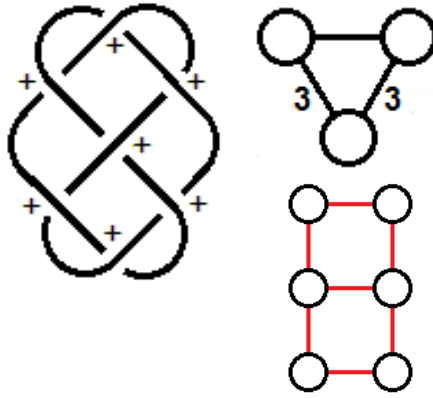

$$v_{\text{even}} = x_{7.4}$$

$$v_{\text{odd}} = \pm y_{7.4}$$

v_2	$4x_{3.1}$
v_3	$\pm 8y_{3.1}$
v_4	$4x_{5.2} + 2x_{4.1} - 2x_{3.1}$
v_5	$\pm(2y_{6.1} + 6y_{5.2} - 8y_{3.1})$
v_6	$-5x_{7.7} + 2x_{7.6} - 2x_{7.5} + 2x_{7.3} + 2x_{6.3} - 6x_{6.2} + 2x_{6.1}$ $- 4x_{5.2} - x_{5.1} + 10x_{4.1} + 12x_{3.1}$

7₅:

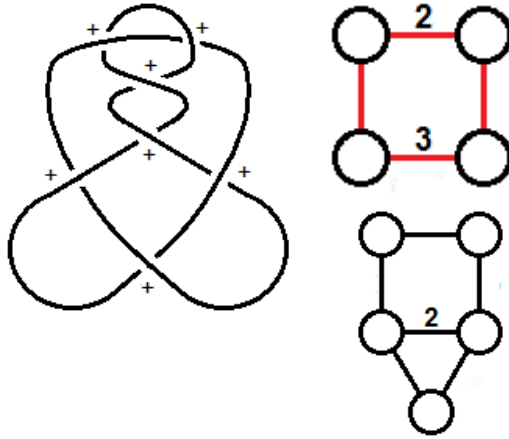

$$v_{\text{even}} = x_{7.5}$$

$$v_{\text{odd}} = \pm y_{7.5}$$

v_2	$4x_{3.1}$
v_3	$\pm 8y_{3.1}$
v_4	$x_{5.2} + 2x_{5.1} - x_{4.1} - 5x_{3.1}$
v_5	$\mp(y_{6.2} - 2y_{5.2} - 2y_{5.1} + 9y_{3.1})$
v_6	$x_{7.5}$

7₆:

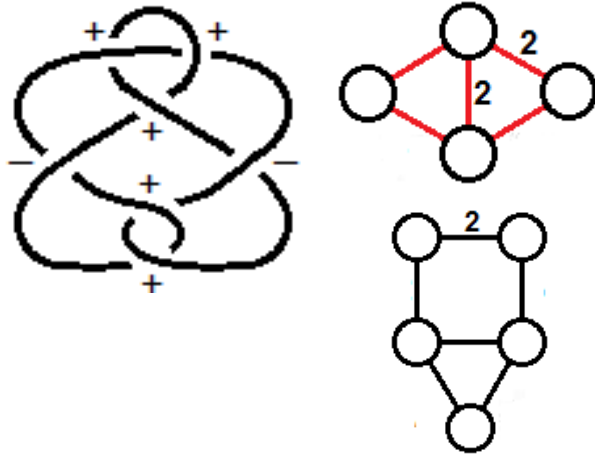

$$v_{\text{even}} = x_{7.6}$$

$$v_{\text{odd}} = \pm y_{7.6}$$

v_2	$x_{3.1}$
v_3	$\pm 2y_{3.1}$
v_4	$3x_{5.2} - x_{5.1} - 2x_{3.1}$
v_5	$\mp(y_{6.2} - y_{6.1} - 3y_{5.2} + y_{5.1} + 2y_{3.1})$
v_6	$x_{7.6}$

7₇:

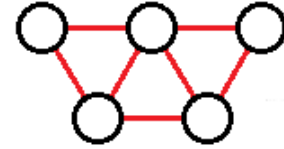
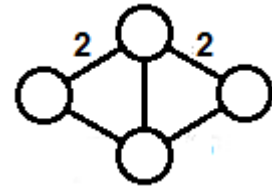
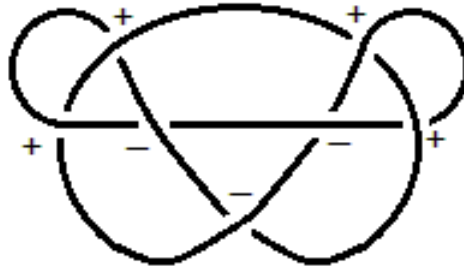

$$v_{\text{even}} = x_{7.7}$$

$$v_{\text{odd}} = \pm y_{7.7}$$

v_2	$-x_{3.1}$
v_3	$\mp y_{3.1}$
v_4	$-2x_{5.2} + x_{5.1}$
v_5	$\pm(2y_{6.2} - 2y_{6.1} - 2y_{5.2} + y_{5.1})$
v_6	$x_{7.7}$

7_{3.1#4.1}:

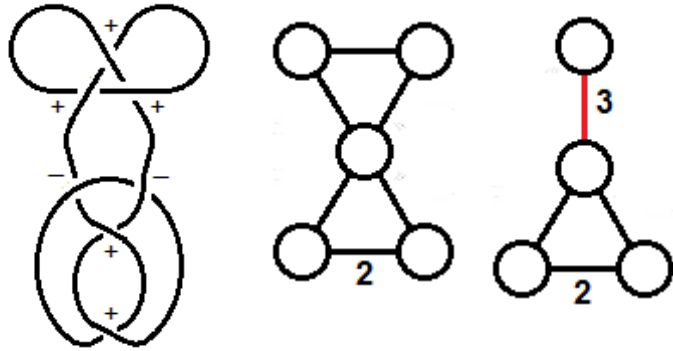

$$v_{\text{even}} = x_{3\#4}$$

$$v_{\text{odd}} = \pm y_{3\#4}$$

v_2	0
v_3	$\pm y_{3.1}$
v_4	$3x_{5.2} - x_{5.1} - 3x_{3.1}$
v_5	$\pm(y_{6.2} - 2y_{6.1} + y_{5.2} - 3y_{3.1})$
v_6	$\frac{1}{8}(12x_{7.7} + x_{7.6} + 2x_{7.5} - 4x_{7.3} + 5x_{7.2} - 7x_{6.3} + 17x_{6.2} - 10x_{6.1} - 6x_{5.2} + 9x_{5.1} - 7x_{4.1} - 10x_{3.1})$

8₁:

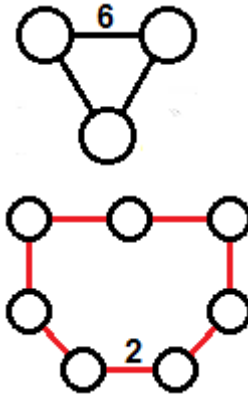
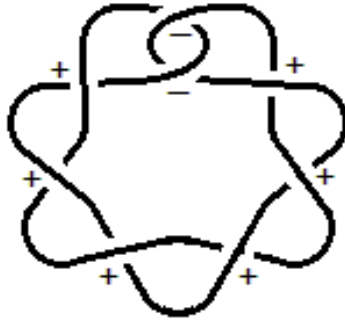

$$v_{\text{even}} = x_{8.1}$$

$$v_{\text{odd}} = \pm y_{8.1}$$

v_2	$-3x_{3.1}$
v_3	$\mp 3y_{3.1}$
v_4	$-4x_{5.2} + 10x_{4.1} + 15x_{3.1}$
v_5	$\pm(5y_{6.1} - y_{5.2} + 5y_{3.1})$
v_6	$-x_{7.2} + 6x_{6.1} + 6x_{5.2} - 15x_{4.1} - 15x_{3.1}$

8₂:

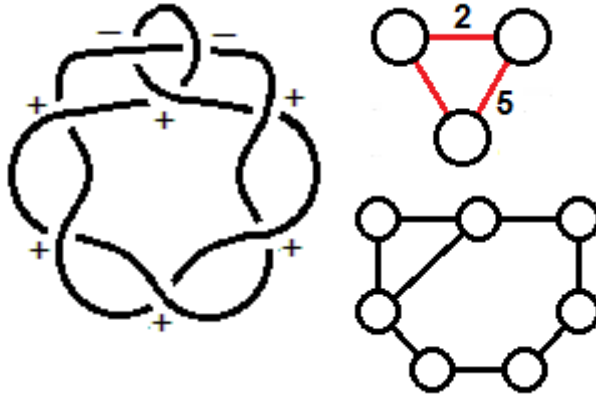

$$v_{\text{even}} = x_{8.2}$$

$$v_{\text{odd}} = \pm y_{8.2}$$

v_2	0
v_3	$\mp y_{3.1}$
v_4	$3x_{5.2} - 3x_{5.1} + 6x_{4.1} + 9x_{3.1}$
v_5	$\pm(4y_{6.2} + y_{5.2} - y_{5.1} + 5y_{3.1})$
v_6	$x_{7.3} - x_{7.1} + 5x_{6.2} - 5x_{5.2} + 5x_{5.1}$ $- 10x_{4.1} - 9x_{3.1}$

8₃:

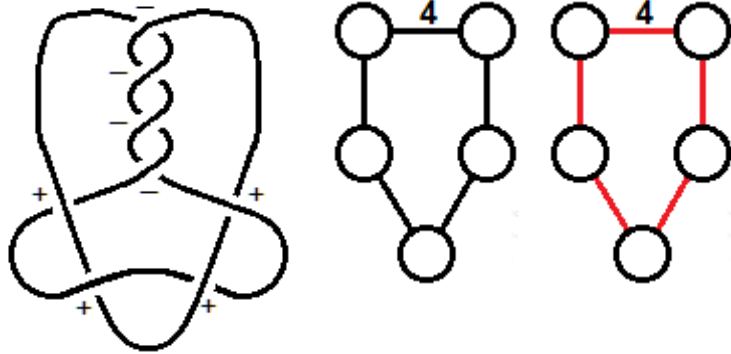

$$v_{\text{even}} = x_{8.3}$$

$$v_{\text{odd}} = 0$$

v_2	$-4x_{3.1}$
v_3	0
v_4	$-4x_{5.2} + 14x_{4.1} + 18x_{3.1}$
v_5	0
v_6	$5x_{7.7} - 2x_{7.6} + 2x_{7.5} - 2x_{7.3} - 2x_{6.3} + 6x_{6.2} + 6x_{6.1}$ $+ 12x_{5.2} + x_{5.1} - 26x_{4.1} - 28x_{3.1}$

8₄:

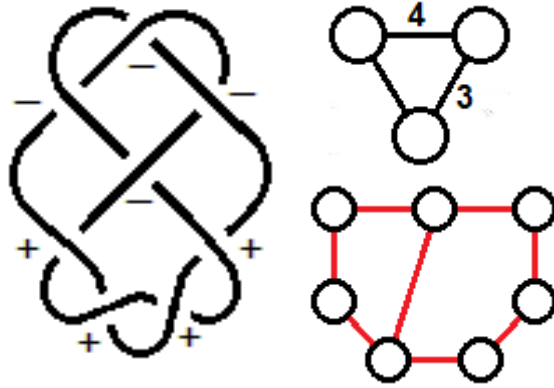

$$v_{\text{even}} = x_{8.4}$$

$$v_{\text{odd}} = \pm y_{8.4}$$

v_2	$-3x_{3.1}$
v_3	$\pm y_{3.1}$
v_4	$x_{5.2} - 2x_{5.1} + 11x_{4.1} + 12x_{3.1}$
v_5	$\mp(3y_{6.2} - 2y_{6.1} - 2y_{5.2} + y_{5.1} + y_{3.1})$
v_6	$-x_{7.3} + x_{7.2} + 4x_{6.2} + 3x_{6.1} - x_{5.2}$ $+ 4x_{5.1} - 11x_{4.1} - 12x_{3.1}$

8₅:

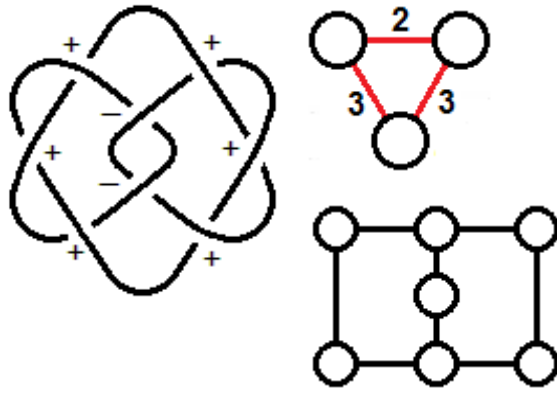

$$v_{\text{even}} = x_{8.5}$$

$$v_{\text{odd}} = \pm y_{8.5}$$

v_2	$-x_{3.1}$
v_3	$\mp 3y_{3.1}$
v_4	$x_{5.2} - 3x_{5.1} + 9x_{4.1} + 15x_{3.1}$
v_5	$\pm(6y_{6.2} - 2y_{5.2} + 9y_{3.1})$
v_6	$\frac{1}{8}(44x_{7.7} - x_{7.6} + 6x_{7.5} - x_{7.2} - 8x_{7.1} - 9x_{6.3} + 91x_{6.2} - 2x_{6.1} - 14x_{5.2} + 59x_{5.1} - 197x_{4.1} - 186x_{3.1})$

8₆:

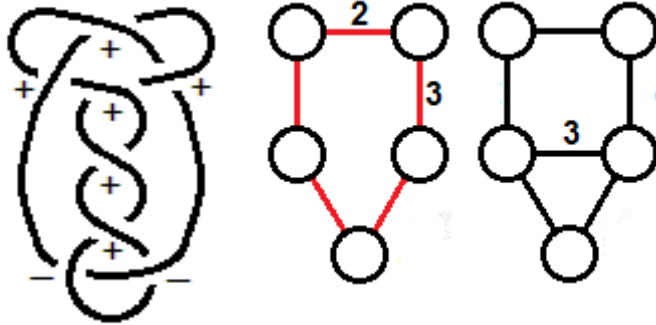

$$v_{\text{even}} = x_{8.6}$$

$$v_{\text{odd}} = \pm y_{8.6}$$

v_2	$-2x_{3.1}$
v_3	$\mp 3y_{3.1}$
v_4	$-2x_{5.1} + 9x_{4.1} + 13x_{3.1}$
v_5	$\pm(3y_{6.2} + 2y_{6.1} - y_{5.2} + 5y_{3.1})$
v_6	$x_{7.6} - x_{7.5} + x_{6.3} + 3x_{6.2} + 3x_{6.1}$ $+ 3x_{5.1} - 12x_{4.1} - 12x_{3.1}$

8₇:

$$v_{\text{even}} = x_{8.7}$$

$$v_{\text{odd}} = \pm y_{8.7}$$

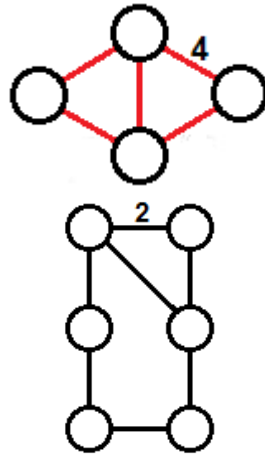
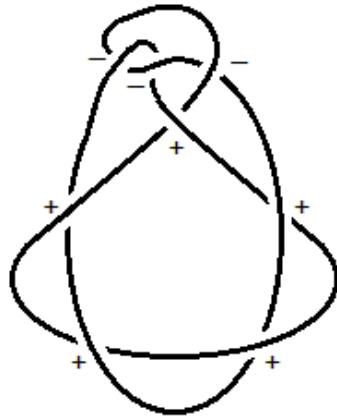

v_2	$2x_{3.1}$
v_3	$\pm 2y_{3.1}$
v_4	$-5x_{5.2} + 3x_{5.1} - 3x_{4.1}$
v_5	$\mp(y_{6.2} + 2y_{5.2} - y_{5.1} - 2y_{3.1})$
v_6	$-x_{7.5} - x_{7.3} + x_{7.1} + 4x_{6.3} - x_{6.2} + 8x_{5.2}$ $- 3x_{5.1} + 4x_{4.1} - 3x_{3.1}$

8₈:

$$v_{\text{even}} = x_{8.8}$$

$$v_{\text{odd}} = \pm y_{8.8}$$

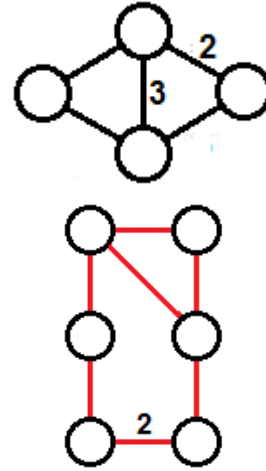

v_2	$2x_{3.1}$
v_3	$\pm y_{3.1}$
v_4	$-4x_{5.2} + 2x_{5.1} - x_{4.1} + 3x_{3.1}$
v_5	$\mp(y_{6.2} - y_{6.1} - y_{3.1})$
v_6	$-x_{7.6} + x_{7.5} - x_{7.2} + 3x_{6.3} + x_{6.2} - x_{6.1}$ $+ 6x_{5.2} - 3x_{5.1} + 3x_{4.1} - 2x_{3.1}$

8₉:

$$v_{\text{even}} = x_{8.9}$$

$$v_{\text{odd}} = 0$$

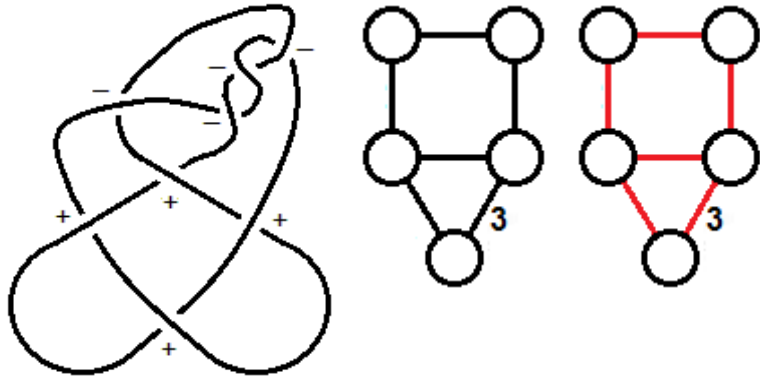

v_2	$-2x_{3.1}$
v_3	0
v_4	$4x_{5.2} - 3x_{5.1} + 8x_{4.1} + 7x_{3.1}$
v_5	0
v_6	$2x_{7.5} - x_{7.1} - x_{6.3} + 6x_{6.2} - 6x_{5.2}$ $+ 5x_{5.1} - 9x_{4.1} - 9x_{3.1}$

8₁₀:

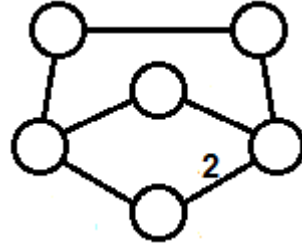
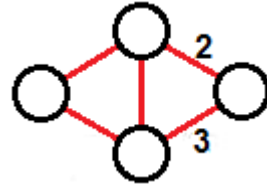

$$v_{\text{even}} = x_{8.10}$$

$$v_{\text{odd}} = \pm y_{8.10}$$

v_2	$3x_{3.1}$
v_3	$\pm 3y_{3.1}$
v_4	$-6x_{5.2} + 3x_{5.1} + 6x_{3.1}$
v_5	$\mp(3y_{6.2} - 4y_{6.1} - 4y_{3.1})$
v_6	$\frac{1}{8}(-68x_{7.7} + 15x_{7.6} - 26x_{7.5} + 8x_{7.3} - x_{7.2} + 8x_{7.1} + 63x_{6.3} - 69x_{6.2} + 14x_{6.1} - 14x_{5.2} - 29x_{5.1} + 179x_{4.1} + 150x_{3.1})$

8₁₁:

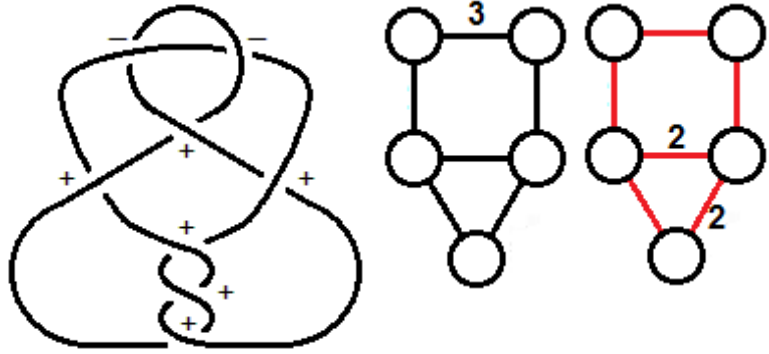

$$v_{\text{even}} = x_{8.11}$$

$$v_{\text{odd}} = y_{8.11}$$

v_2	$-x_{3.1}$
v_3	$\mp 2y_{3.1}$
v_4	$x_{5.2} - 2x_{5.1} + 6x_{4.1} + 9x_{3.1}$
v_5	$\pm(y_{6.2} + 3y_{6.1} + y_{5.2} - y_{5.1} + 4y_{3.1})$
v_6	$-4x_{7.7} + 2x_{7.6} - 2x_{7.5} + x_{7.3} + 2x_{6.3} - 2x_{6.2} + 3x_{6.1}$ $- 5x_{5.2} + 2x_{5.1} - x_{4.1} + x_{3.1}$

8₁₂:

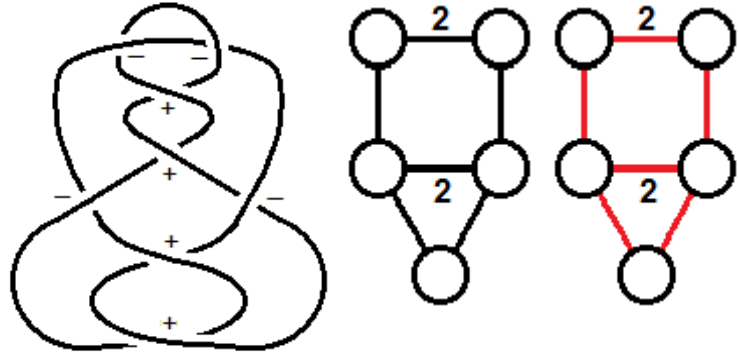

$$v_{\text{even}} = x_{8.12}$$

$$v_{\text{odd}} = 0$$

v_2	$-3x_{3.1}$
v_3	0
v_4	$-4x_{5.2} + x_{5.1} + 7x_{4.1} + 9x_{3.1}$
v_5	0
v_6	$-x_{7.7} - 2x_{7.6} - x_{6.3} - 2x_{6.2} + 4x_{6.1}$ $+ 4x_{5.2} - x_{5.1} - 4x_{4.1} - 4x_{3.1}$

8₁₃:

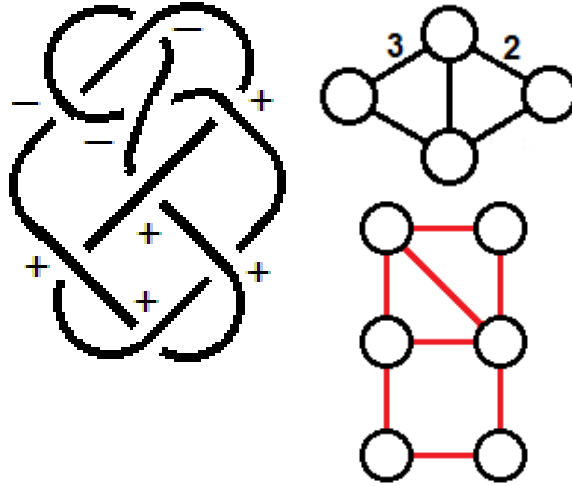

$$v_{\text{even}} = x_{8.13}$$

$$v_{\text{odd}} = \pm y_{8.13}$$

v_2	$x_{3.1}$
v_3	$\pm y_{3.1}$
v_4	$-3x_{5.2} + 2x_{5.1} - 3x_{4.1} - 2x_{3.1}$
v_5	$\pm(y_{6.2} - 2y_{6.1} - 2y_{5.2} + y_{5.1} + y_{3.1})$
v_6	$5x_{7.7} - x_{7.6} + 2x_{7.5} - x_{7.3} - x_{7.2} + x_{6.3} + 5x_{6.2}$ $- 2x_{6.1} + 10x_{5.2} - 2x_{5.1} - 7x_{4.1} - 14x_{3.1}$

8₁₄:

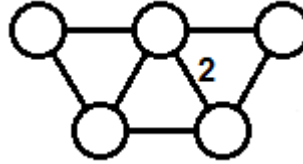
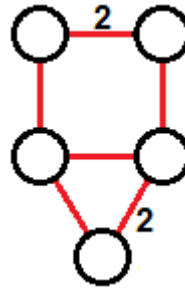
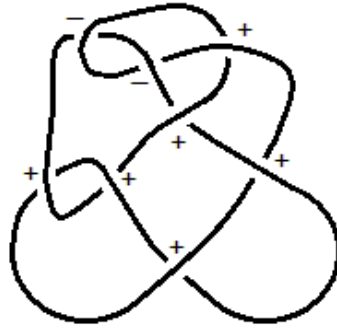

$$v_{\text{even}} = x_{8.14}$$

$$v_{\text{odd}} = \pm y_{8.14}$$

v_2	0
v_3	0
v_4	$3x_{5.2} - 2x_{5.1} + 3x_{4.1} + 3x_{3.1}$
v_5	$\pm(3y_{6.2} - 2y_{6.1} + y_{3.1})$
v_6	$-x_{7.7} - x_{7.6} - x_{7.5} + x_{7.2} - x_{6.3} + x_{6.2}$ $- 2x_{5.2} + 2x_{5.1} - x_{4.1}$

8₁₅:

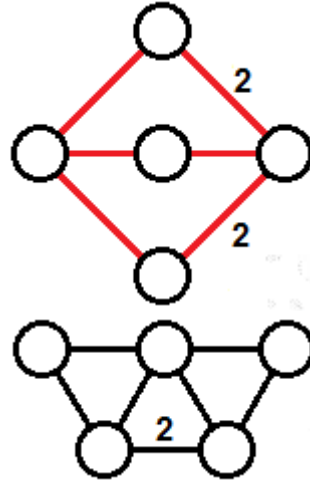
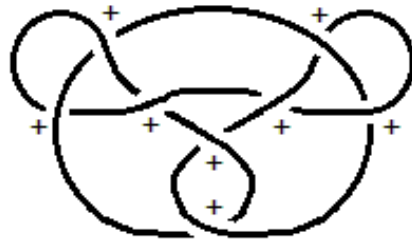

$$v_{\text{even}} = x_{8.15}$$

$$v_{\text{odd}} = \pm y_{8.15}$$

v_2	$4x_{3.1}$
v_3	$\pm 7y_{3.1}$
v_4	$-4x_{5.2} + 3x_{5.1} + x_{4.1} + 4x_{3.1}$
v_5	$\mp(4y_{6.2} - 7y_{6.1} + 4y_{5.2} - 2y_{5.1} - 12y_{3.1})$
v_6	$\frac{1}{8}(-52x_{7.7} + 79x_{7.6} - 18x_{7.5} + 16x_{7.3} - 33x_{7.2} + 31x_{6.3} - 77x_{6.2} + 54x_{6.1} - 78x_{5.2} + 51x_{5.1} - 13x_{4.1} - 18x_{3.1})$

8₁₆:

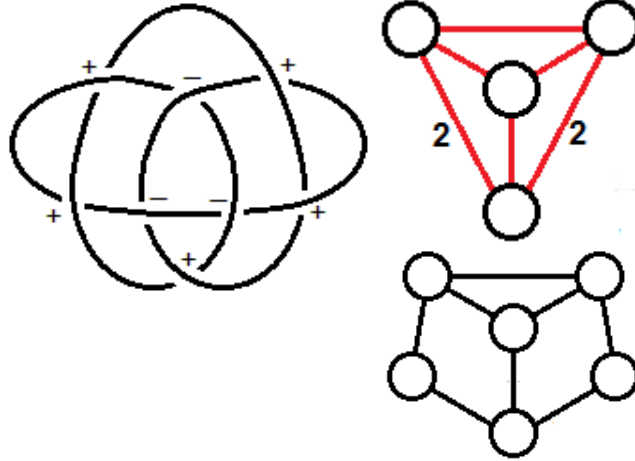

$$v_{\text{even}} = x_{8.16}$$

$$v_{\text{odd}} = \pm y_{8.16}$$

v_2	$x_{3.1}$
v_3	$\pm y_{3.1}$
v_4	$-3x_{5.2} + 2x_{5.1} - 3x_{4.1} - 2x_{3.1}$
v_5	$\mp(4y_{6.2} - 4y_{6.1} - 2y_{5.2} + y_{5.1})$
v_6	$\frac{1}{8}(20x_{7.7} + 5x_{7.6} + 2x_{7.5} - 8x_{7.3} - 11x_{7.2} + 8x_{7.1} + 29x_{6.3} + x_{6.2} - 6x_{6.1} + 118x_{5.2} - 55x_{5.1} + 25x_{4.1} - 46x_{3.1})$

8₁₇:

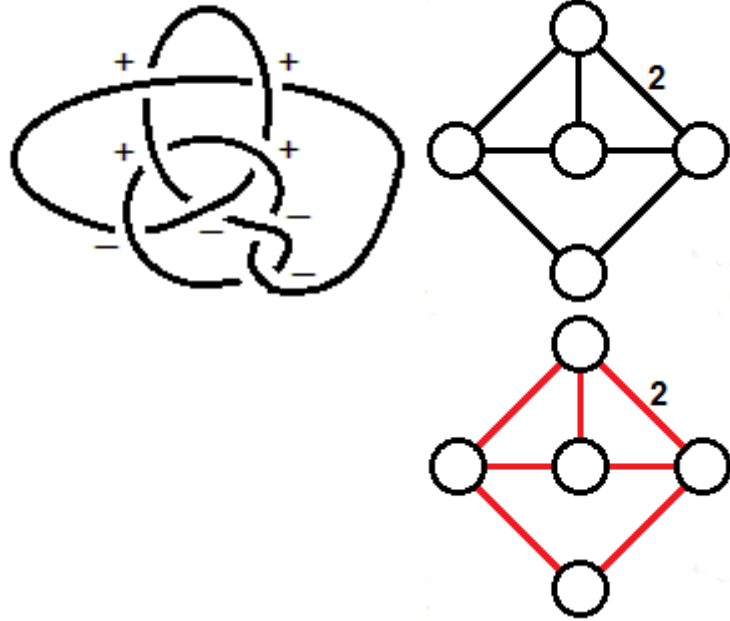

$$v_{\text{even}} = x_{8.17}$$

$$v_{\text{odd}} = 0$$

v_2	$-x_{3.1}$
v_3	0
v_4	$3x_{5.2} - 2x_{5.1} + 4x_{4.1} + 3x_{3.1}$
v_5	0
v_6	$\frac{1}{8}(-28x_{7.7} + 5x_{7.6} + 2x_{7.5} + 8x_{7.3} + 5x_{7.2} - 8x_{7.1} - 11x_{6.3} + x_{6.2} + 10x_{6.1} - 106x_{5.2} + 49x_{5.1} - 23x_{4.1} + 18x_{3.1})$

8₁₈:

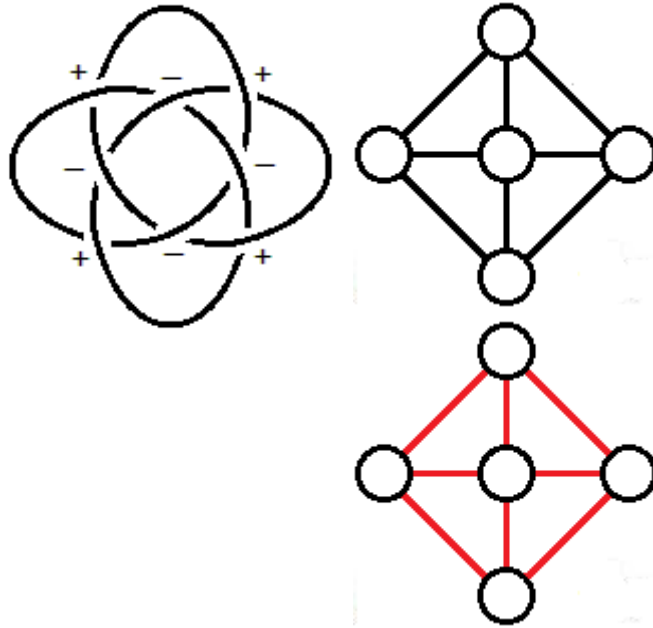

$$v_{even} = x_{8.18}$$

$$v_{odd} = 0$$

v_2	$x_{3.1}$
v_3	0
v_4	$x_{5.2} - x_{5.1} + 2x_{4.1} + 4x_{3.1}$
v_5	0
v_6	$\frac{1}{8}(-60x_{7.7} + 13x_{7.6} - 14x_{7.5} + 16x_{7.3} + 13x_{7.2} - 8x_{7.1} - 11x_{6.3} - 47x_{6.2} + 26x_{6.1} - 186x_{5.2} + 65x_{5.1} + 25x_{4.1} + 138x_{3.1})$

8₁₉:

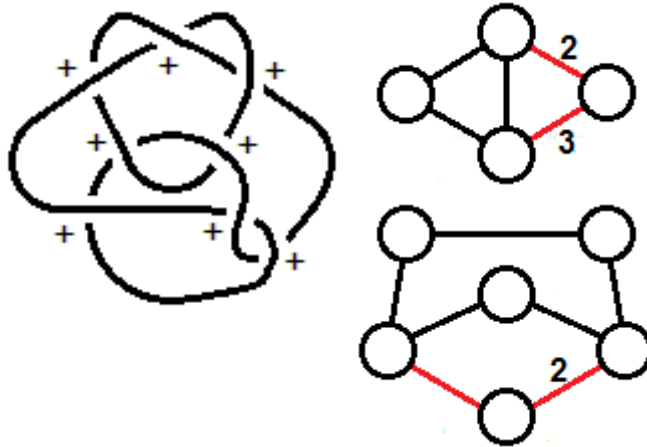

$$v_{\text{even}} = x_{8.19}$$

$$v_{\text{odd}} = \pm y_{8.19}$$

v_2	$5x_{3.1}$
v_3	$\pm 10y_{3.1}$
v_4	$-5x_{5.2} + 5x_{5.1}$
v_5	$\mp(6y_{6.2} - 8y_{6.1} + 4y_{5.2} - 4y_{5.1} - 4y_{3.1})$
v_6	$\frac{1}{8}(-84x_{7.7} + 95x_{7.6} - 26x_{7.5} + 16x_{7.3} - 33x_{7.2} + 8x_{7.1} + 55x_{6.3} - 117x_{6.2} + 62x_{6.1} - 94x_{5.2} + 27x_{5.1} + 83x_{4.1} + 78x_{3.1})$

8₂₀:

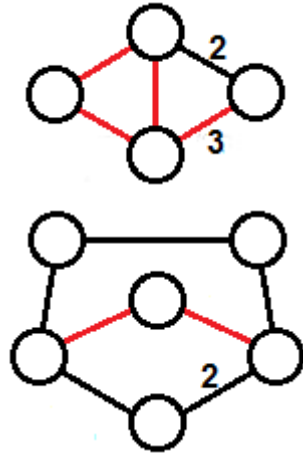

$$v_{\text{even}} = x_{8.20}$$

$$v_{\text{odd}} = \pm y_{8.20}$$

v_2	$2x_{3.1}$
v_3	$\mp 2y_{3.1}$
v_4	$-2x_{5.2} + x_{5.1} + 3x_{3.1}$
v_5	$\pm(3y_{6.2} - 4y_{6.1} - 2y_{5.2} + y_{5.1} - 2y_{3.1})$
v_6	$\frac{1}{8}(-36x_{7.7} + 15x_{7.6} - 10x_{7.5} + 8x_{7.3} - x_{7.2} + 23x_{6.3} - 37x_{6.2} + 14x_{6.1} - 46x_{5.2} + 3x_{5.1} + 59x_{4.1} + 78x_{3.1})$

8₂₁:

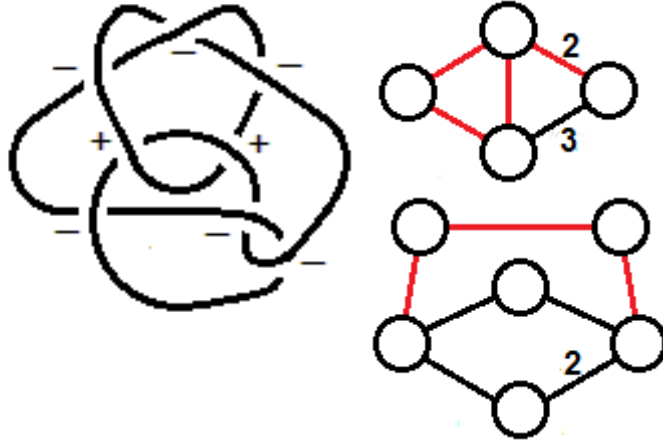

$$v_{\text{even}} = x_{8.21}$$

$$v_{\text{odd}} = \pm y_{8.21}$$

v_2	0
v_3	$\pm y_{3.1}$
v_4	$-x_{5.1} + 3x_{4.1} + 6x_{3.1}$
v_5	$\mp(2y_{6.2} - y_{5.2} + 4y_{3.1})$
v_6	$\frac{1}{8}(12x_{7.7} - x_{7.6} - 2x_{7.5} - x_{7.2} - x_{6.3} + 19x_{6.2} - 2x_{6.1} + 10x_{5.2} + 3x_{5.1} - 29x_{4.1} - 18x_{3.1})$

