



## Appendix D: All graphs with 6 or fewer nodes that correspond to all alternating prime knots with crossing number 11 or less

Remarks:

•1• Knots are sorted according to their generic graphs, and those graphs are sorted by the number of nodes and bundles. Furthermore the graphs are sorted according to the position of the bundles with even multiplicities.

•2• Note that all the knots with crossing number 11 or less, given by the generic graph ,

could also have been given by the graph , with one exception, namely the knot pair **11a44** and **11a47**. For knots with a larger number of crossings there will be an increasing number of exceptions.

•3• Note that all the knots with crossing number 11 or less, given by the generic graph ,

could also have been given by the graph . For knots with more than 11 crossings this is generally not true.

•4• A knot number marked with an asterisk indicates that the graph is its own twin, but not always in exactly the same projection.

•5• A total number of 632 graphs are given corresponding to all 563 alternating prime knots with 11 or fewer crossings. 69 knots are represented twice. Only 49 different generic graph forms are used, or 50 if the exception in •2• above is counted.

## 2:1

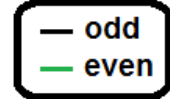
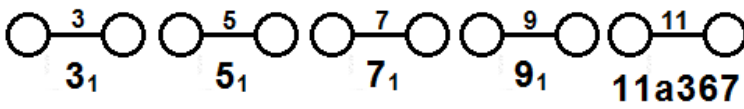

## 3:3

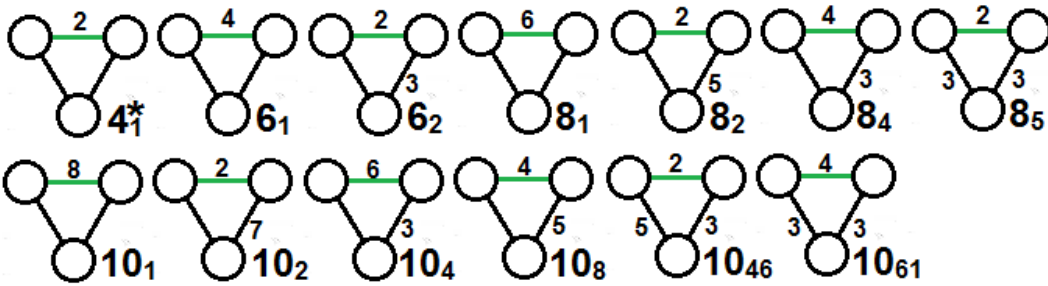
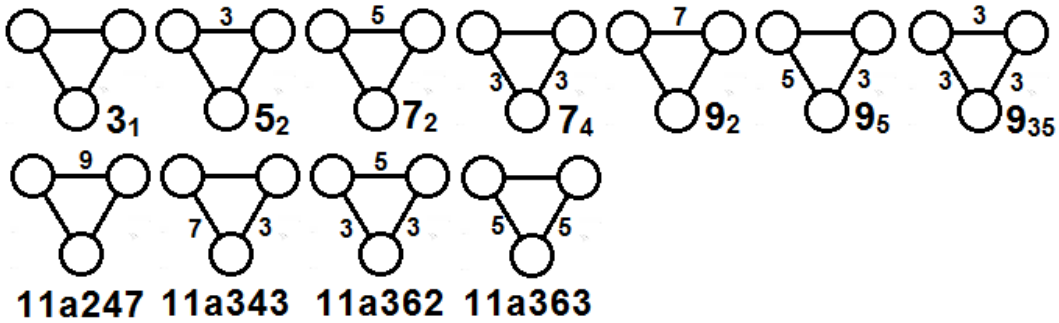

## 4:4

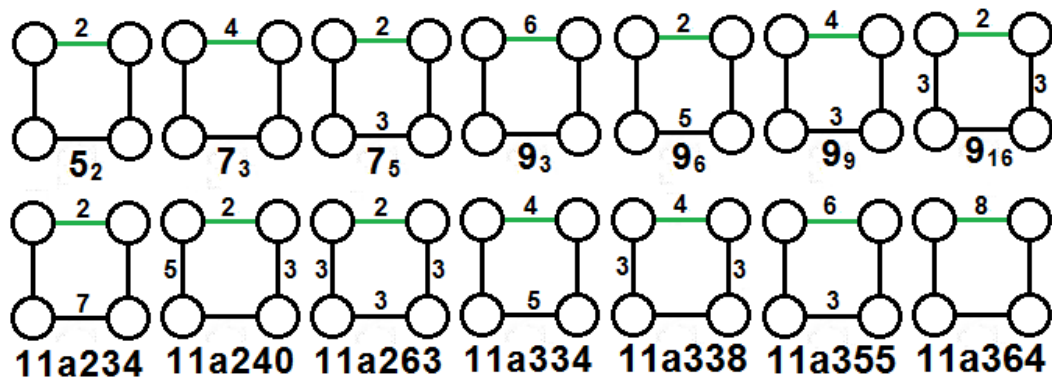

**4:5**

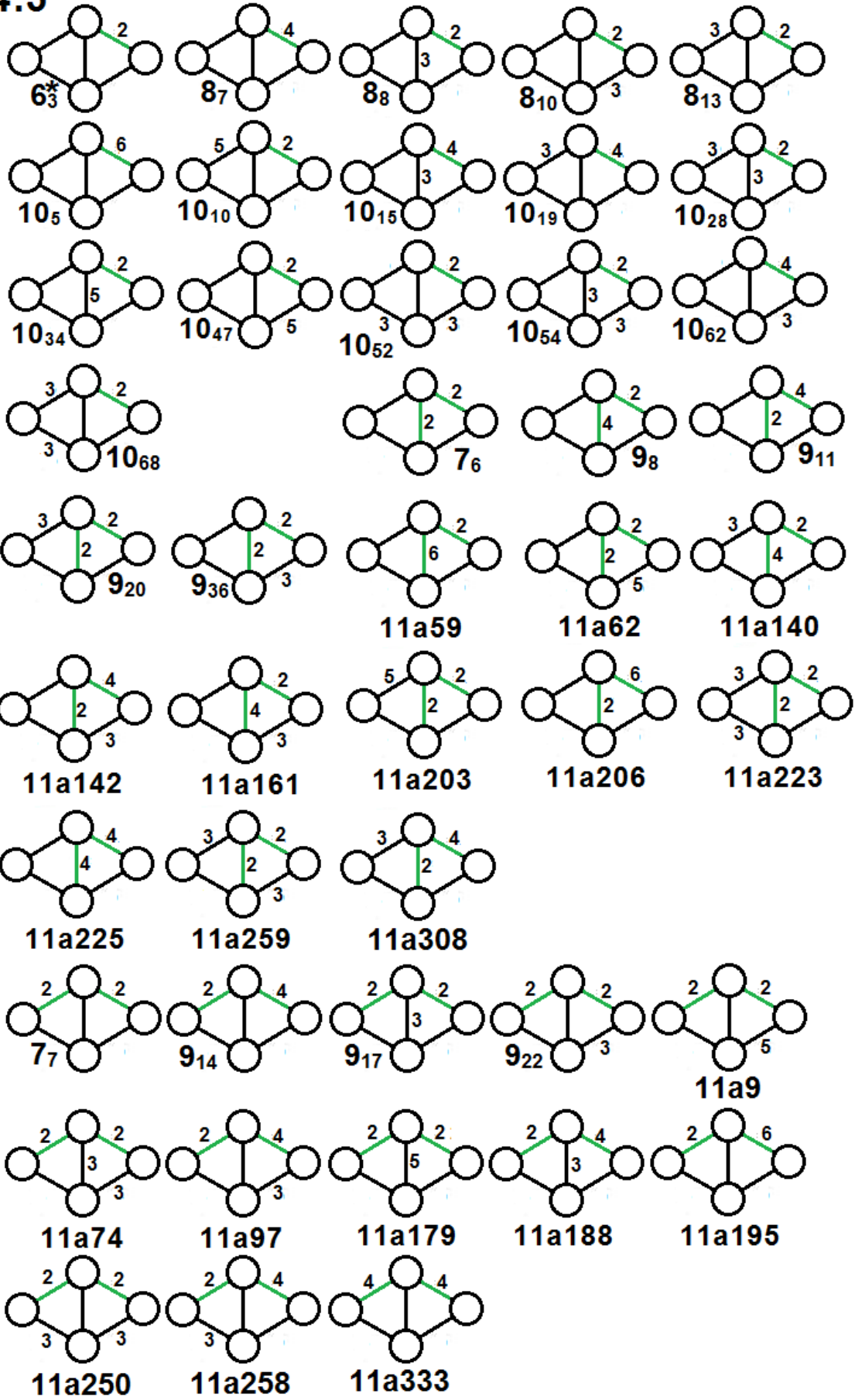

### 4:6

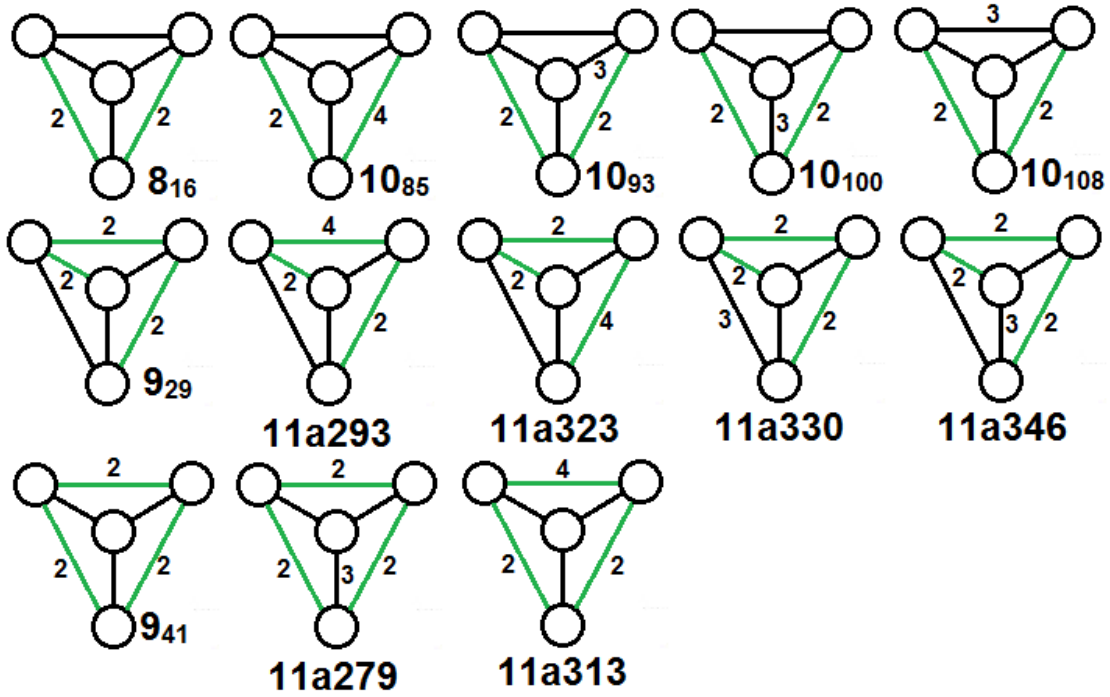

### 5:5

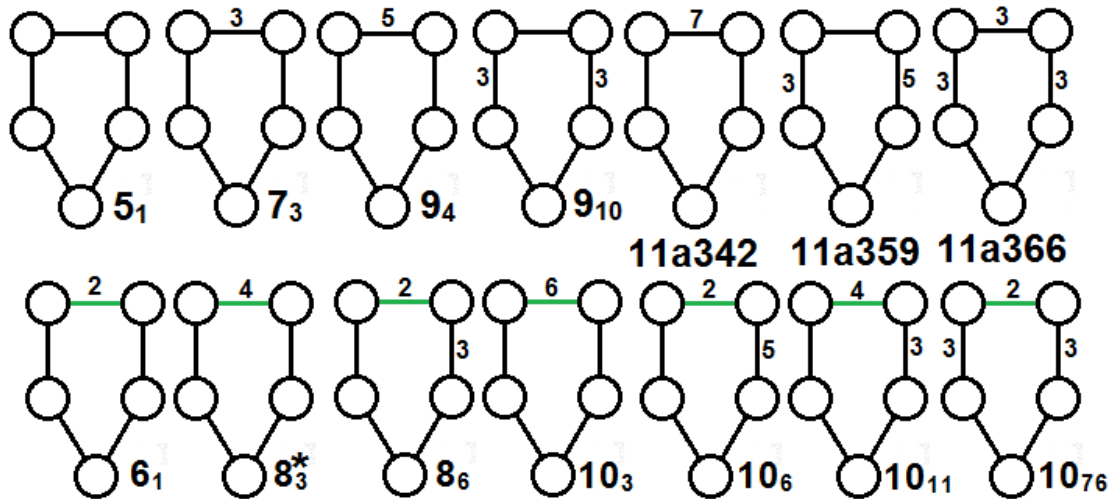

### 5:6

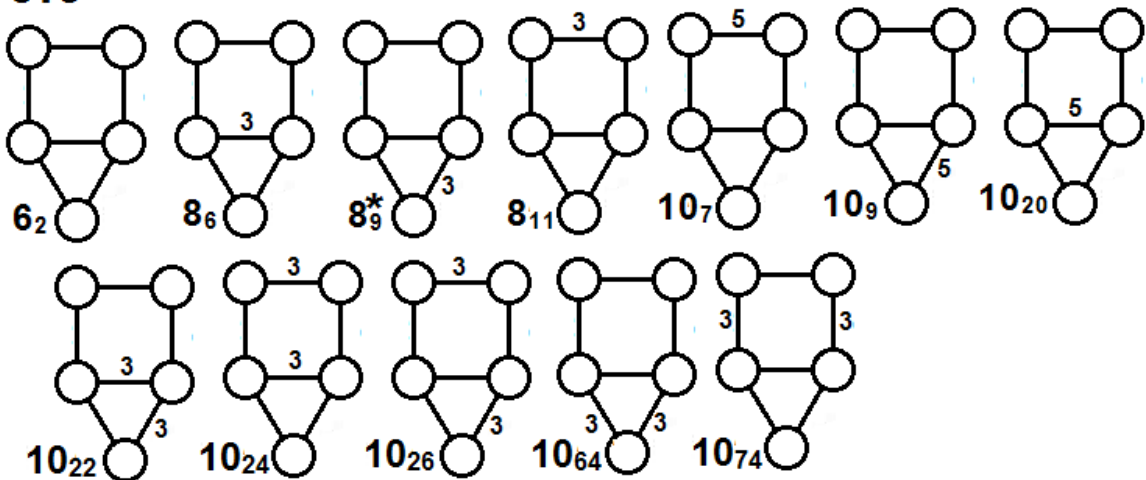

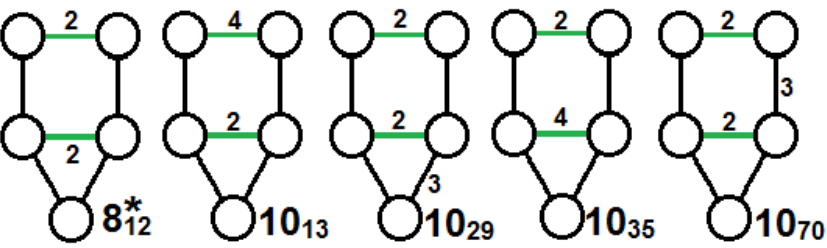
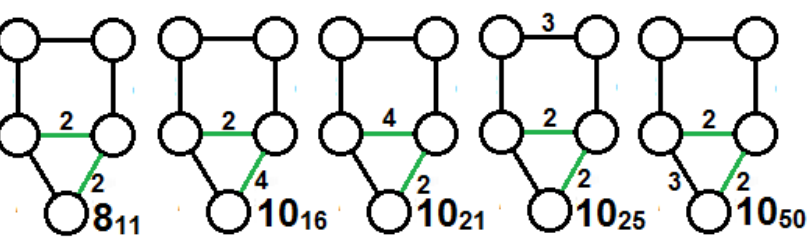
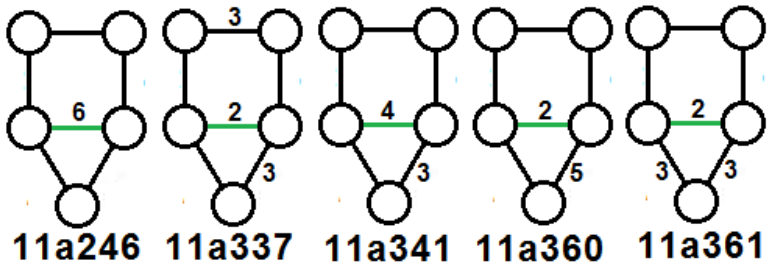
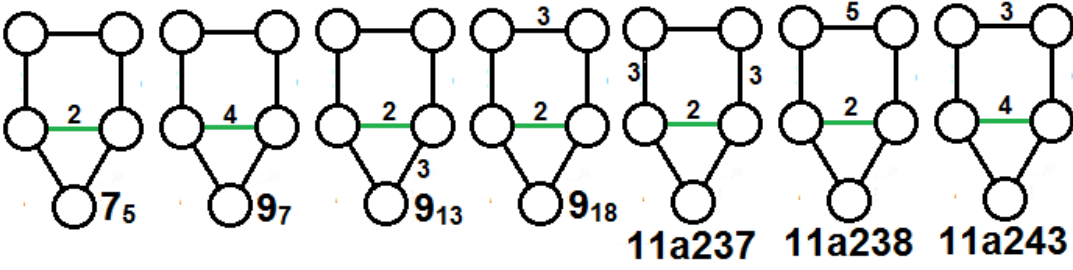
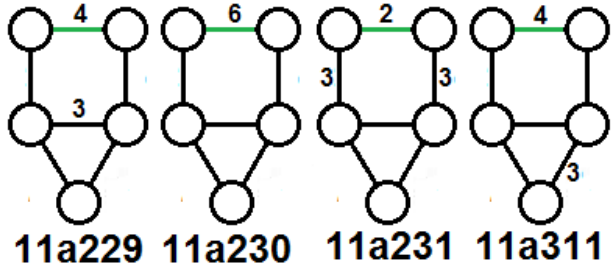
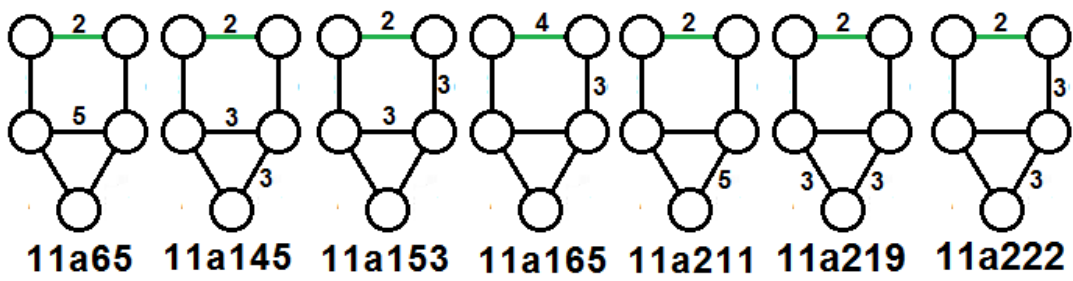
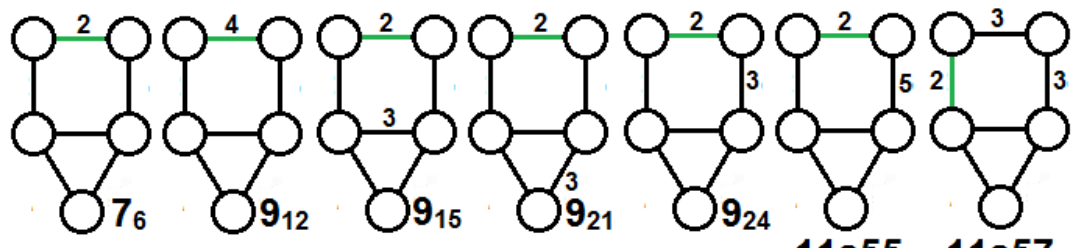

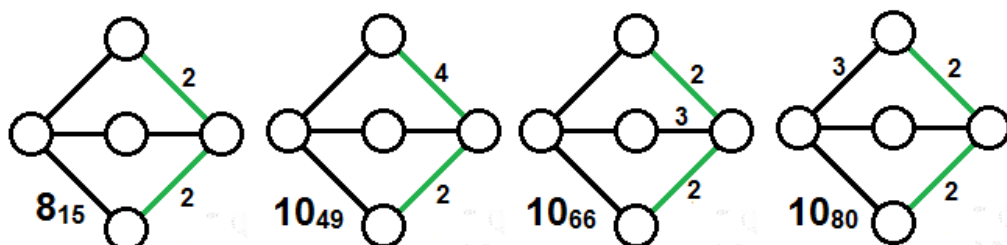
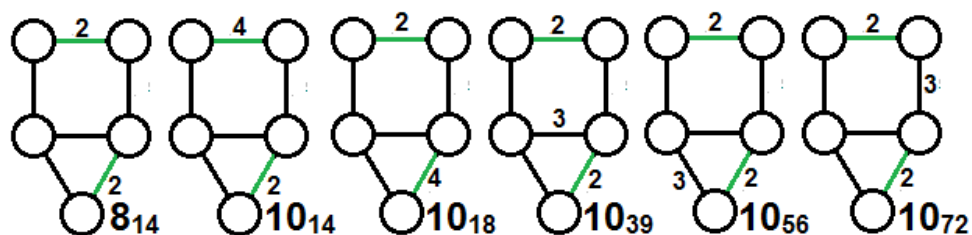

**5:7**

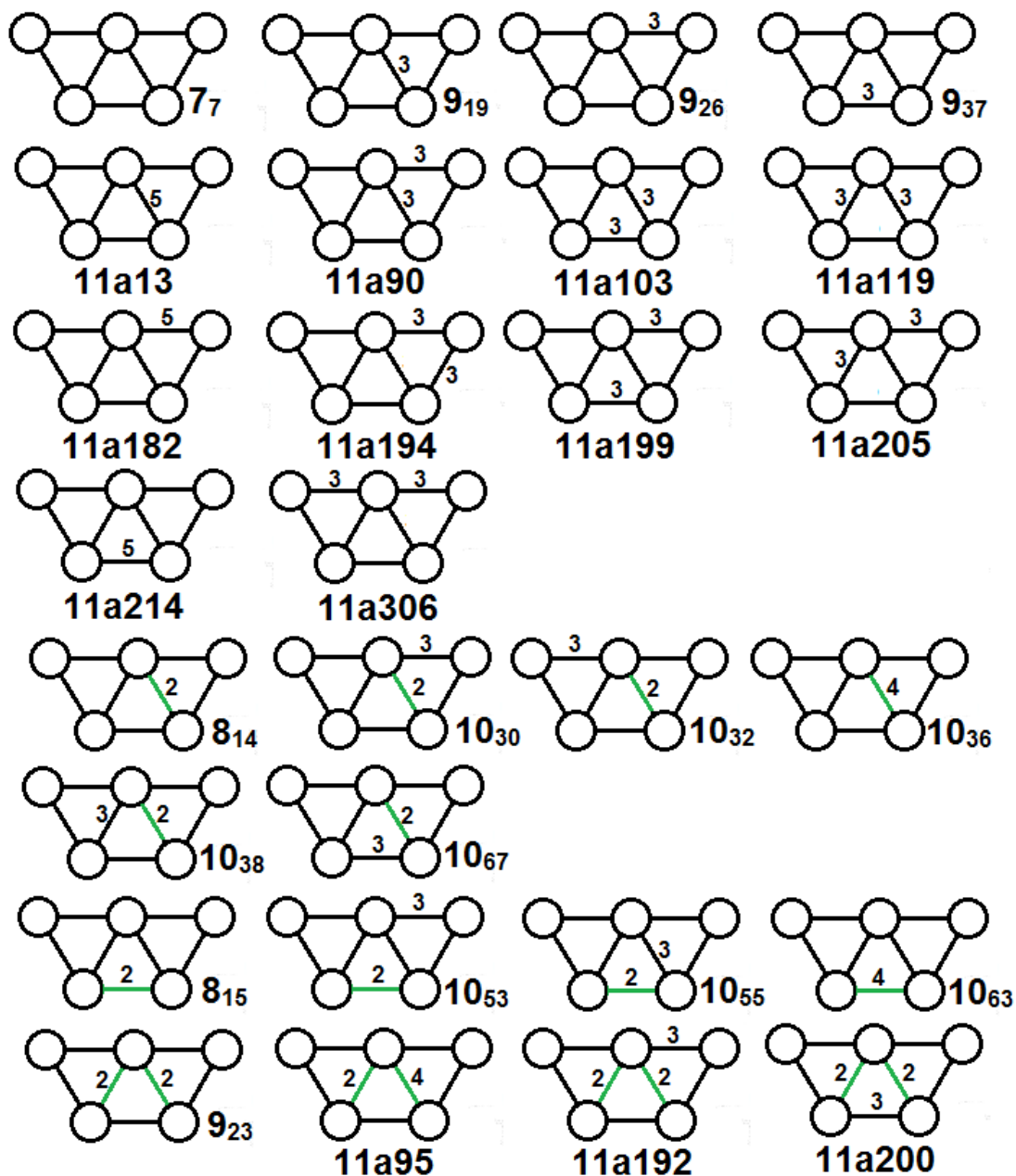

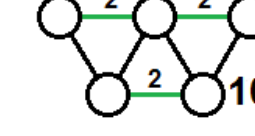
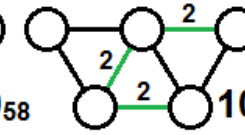
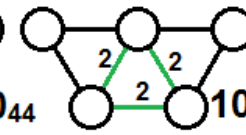
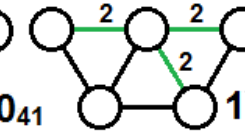
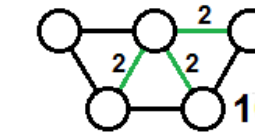
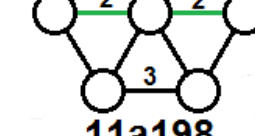
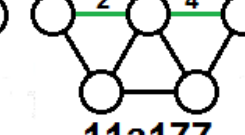
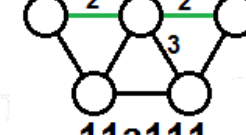
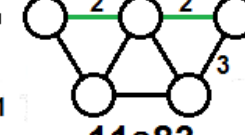
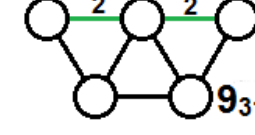
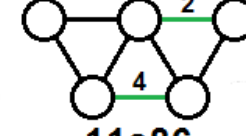
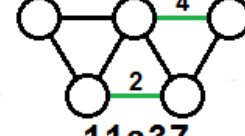
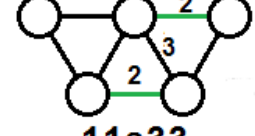
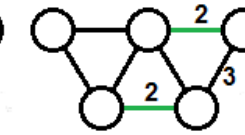
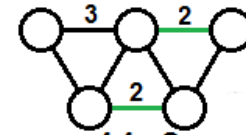
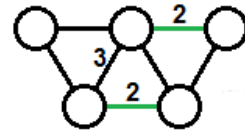
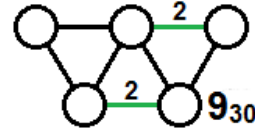
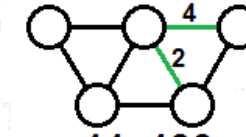
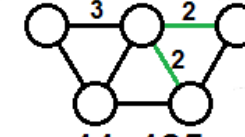
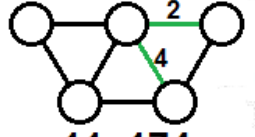
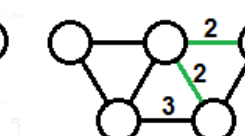
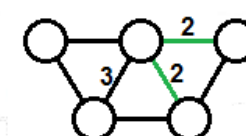
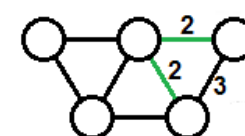
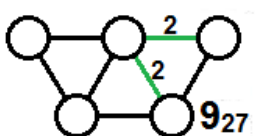
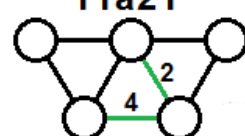
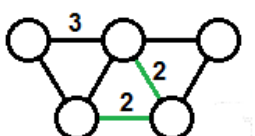
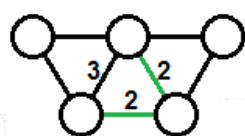
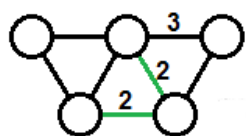
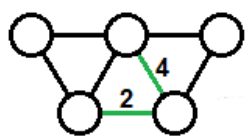
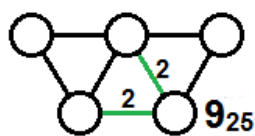

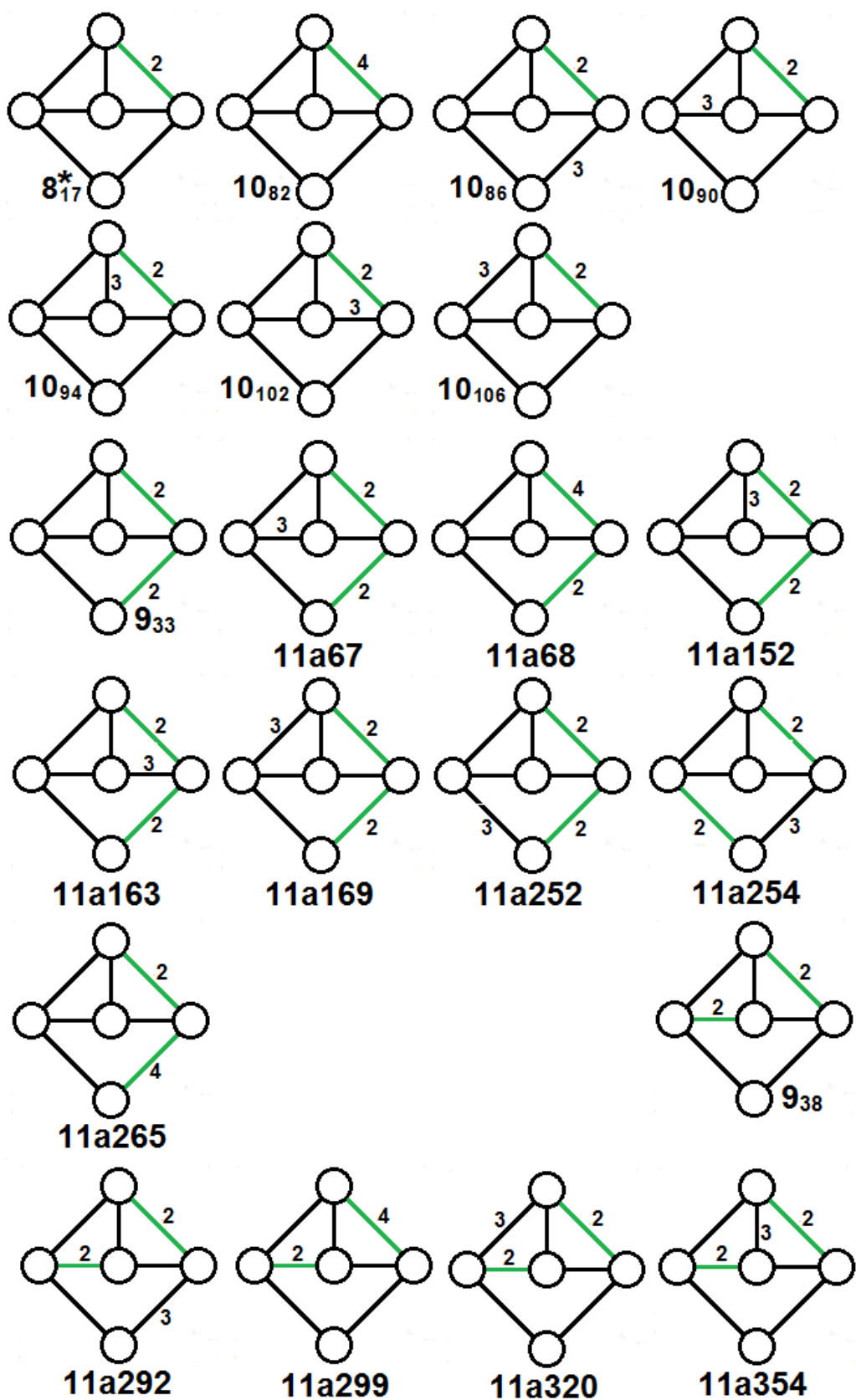



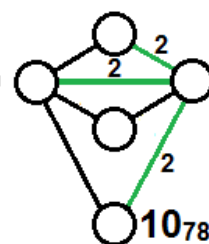
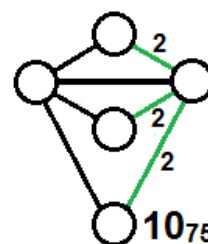
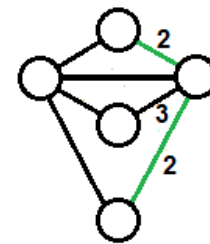
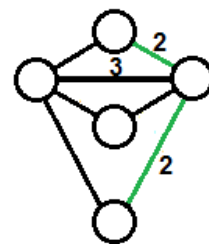
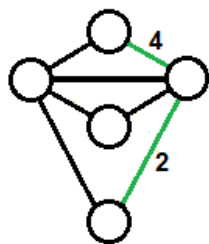
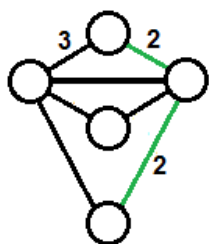
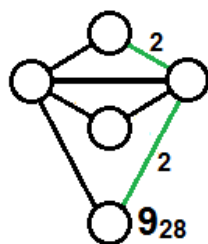
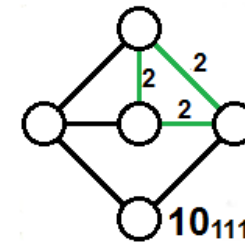
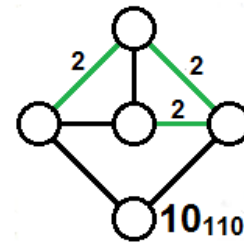
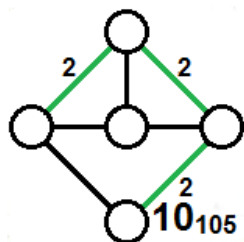
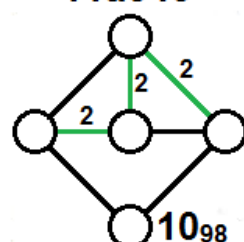
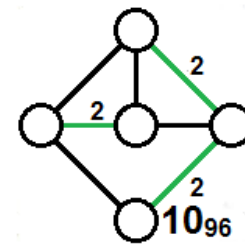
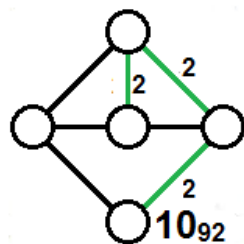
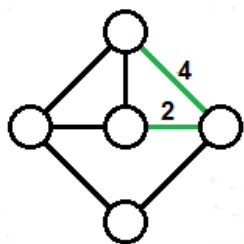
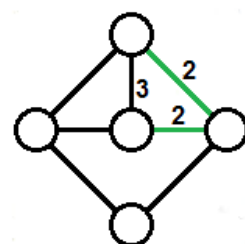
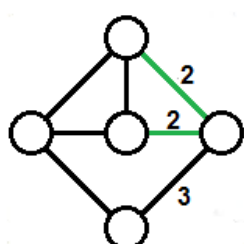
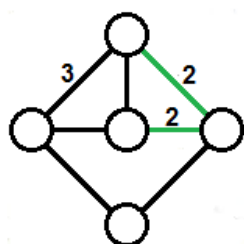
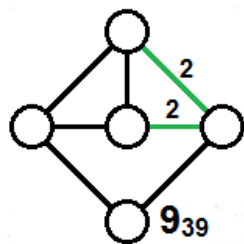

**5:8**

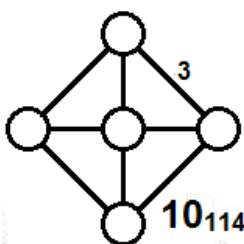
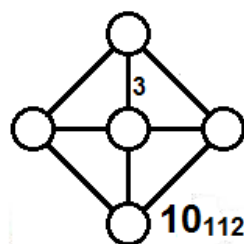
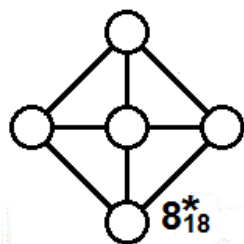

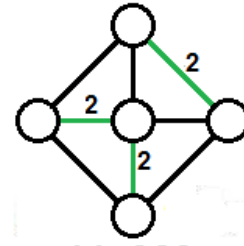
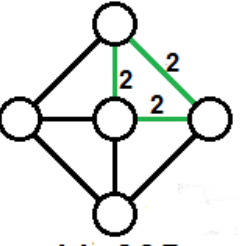
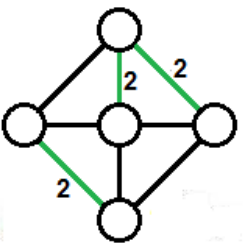
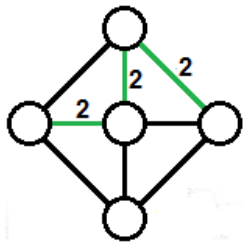
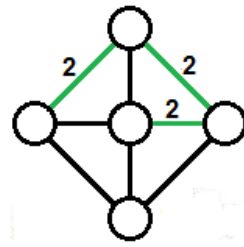
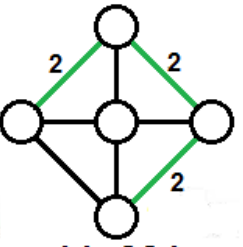
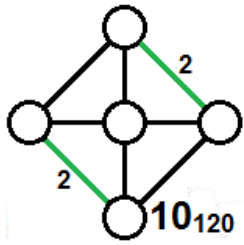
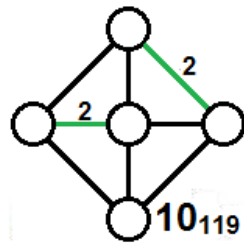
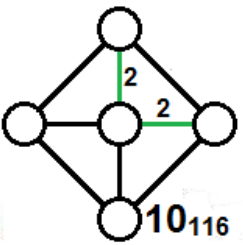
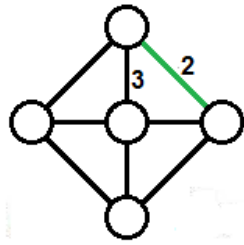
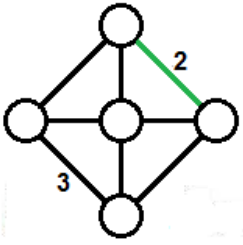
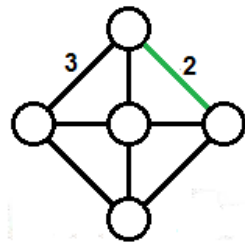
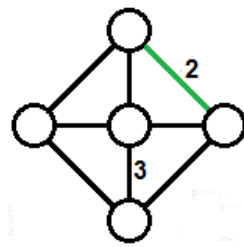
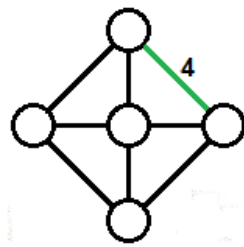
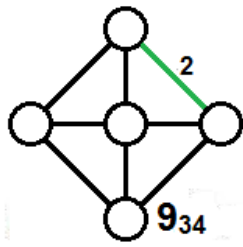

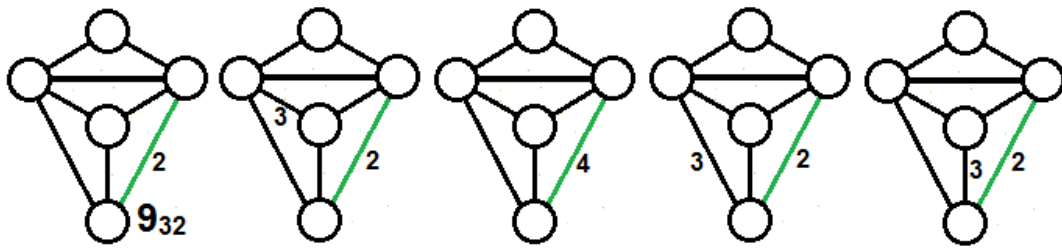

9<sub>32</sub>

11a29

11a53

11a113

11a129

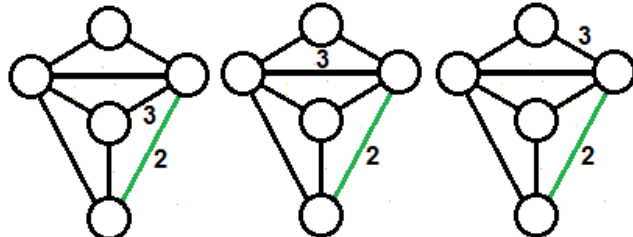

11a137

11a141

11a261

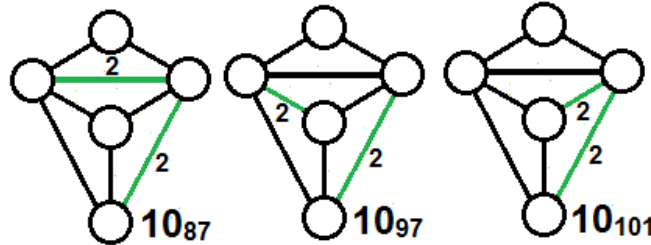

10<sub>87</sub>

10<sub>97</sub>

10<sub>101</sub>

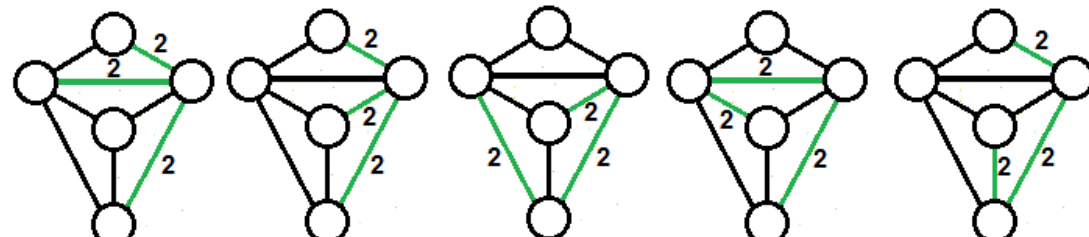

11a81

11a99

11a115

11a123

11a127

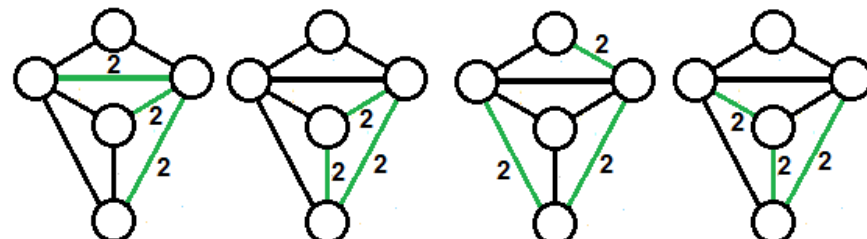

11a148

11a158

11a215

11a232

**5:9**

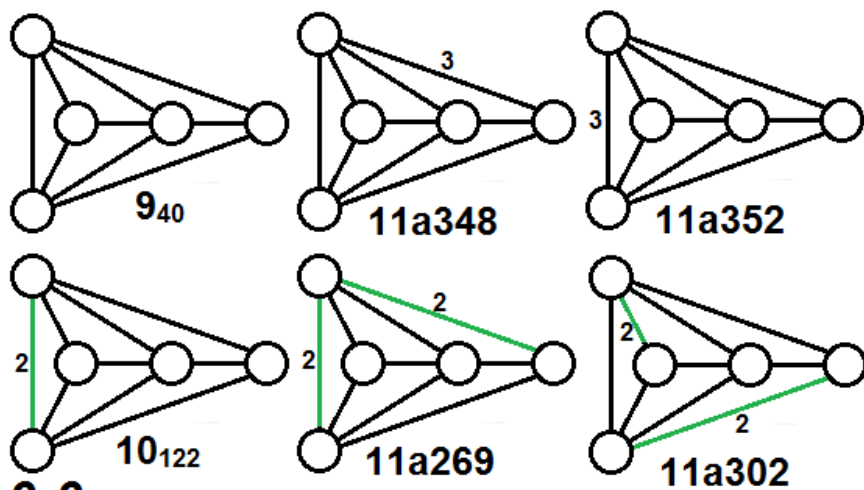

**6:6**

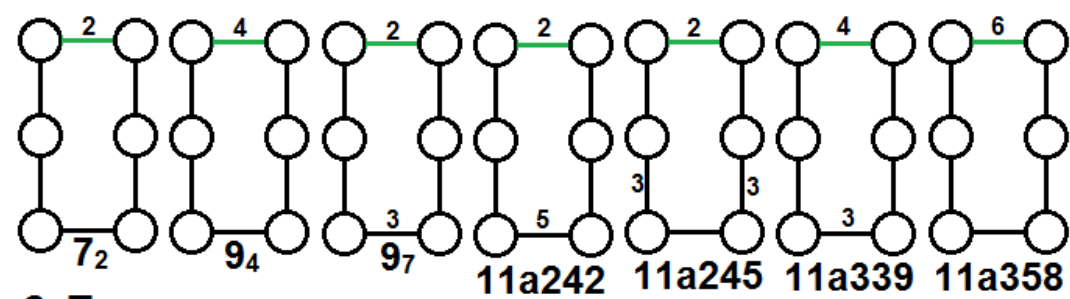

**6:7**

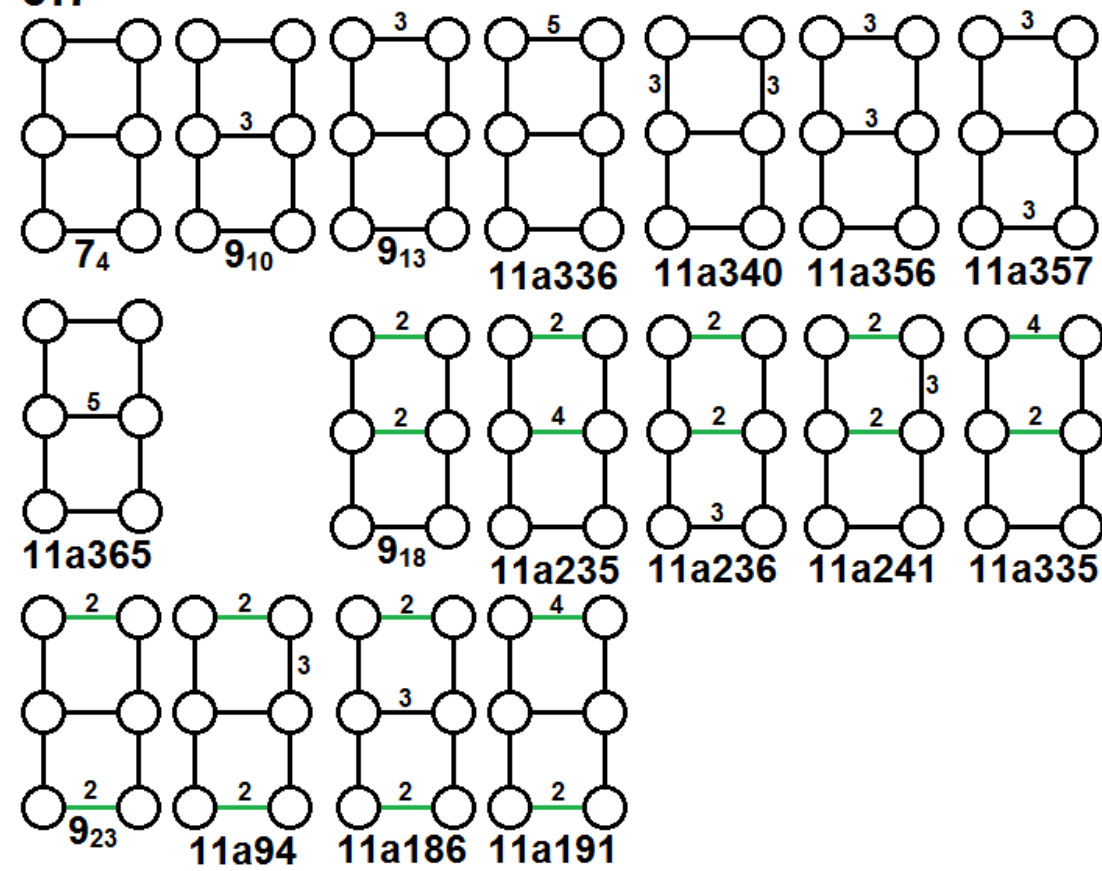

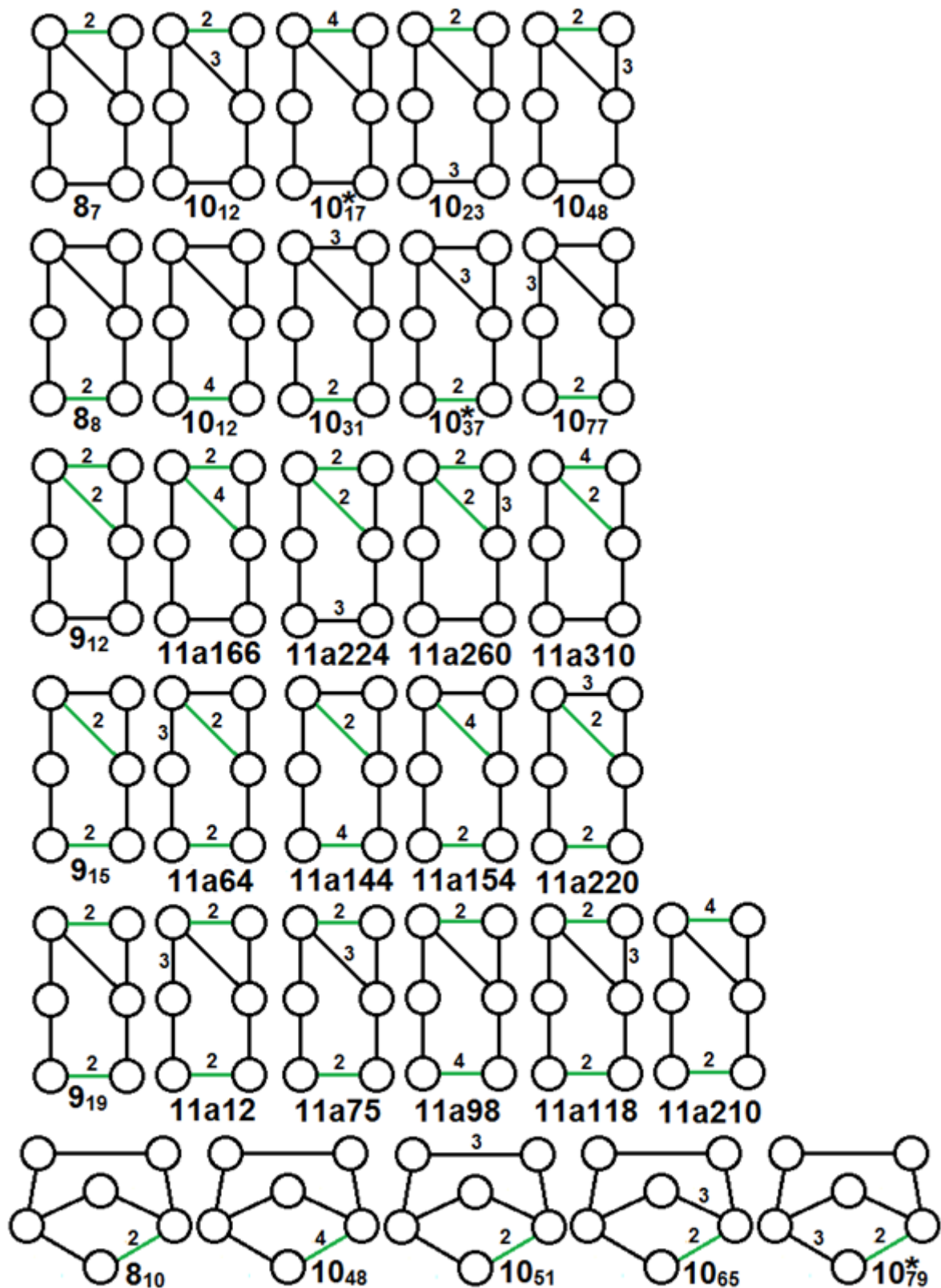

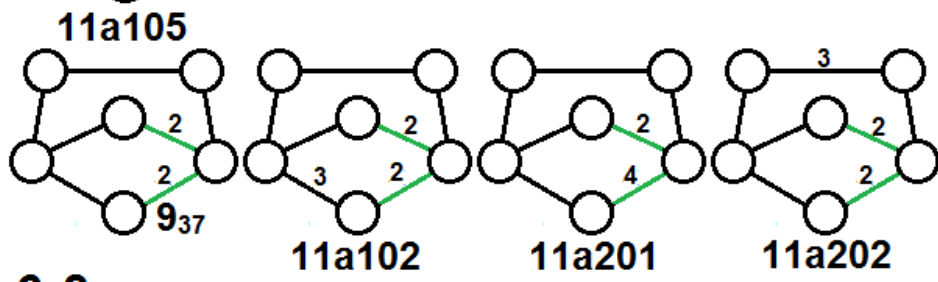
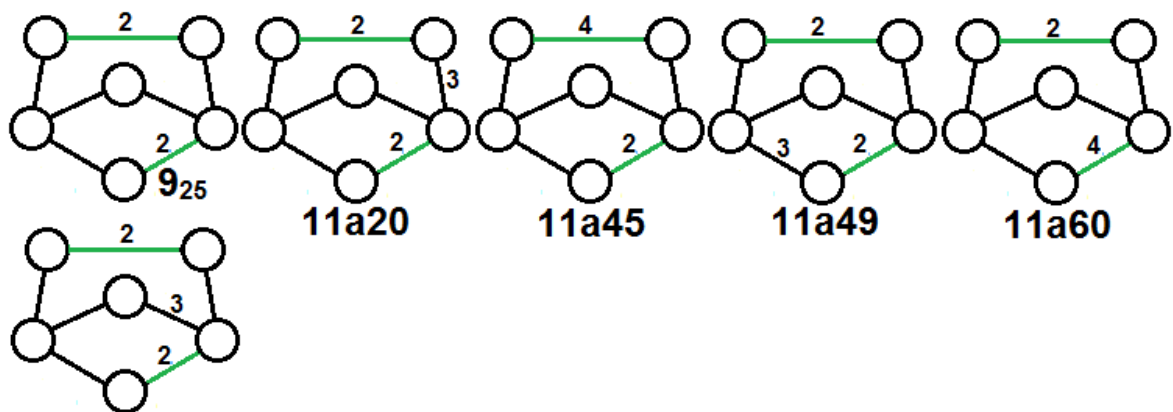

**6:8**

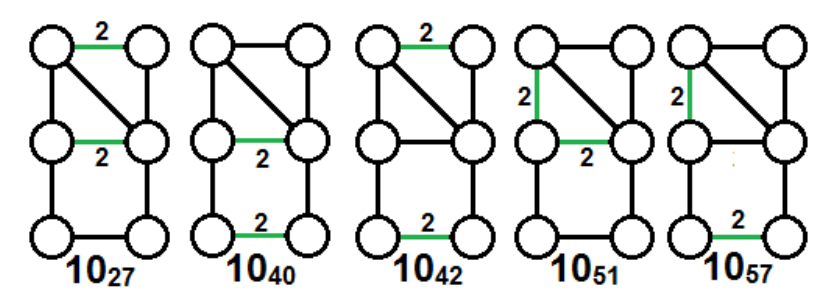
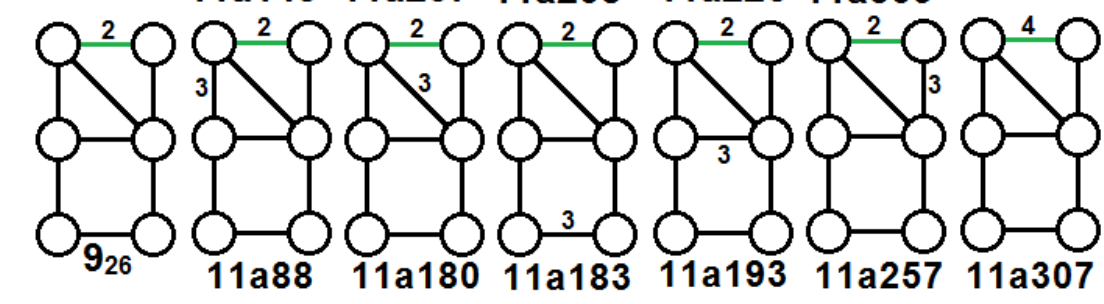
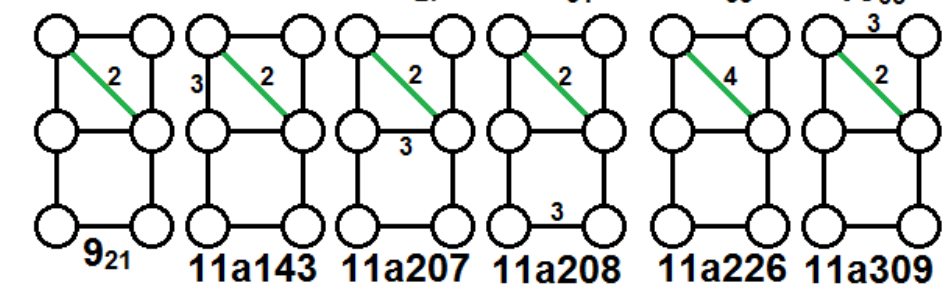
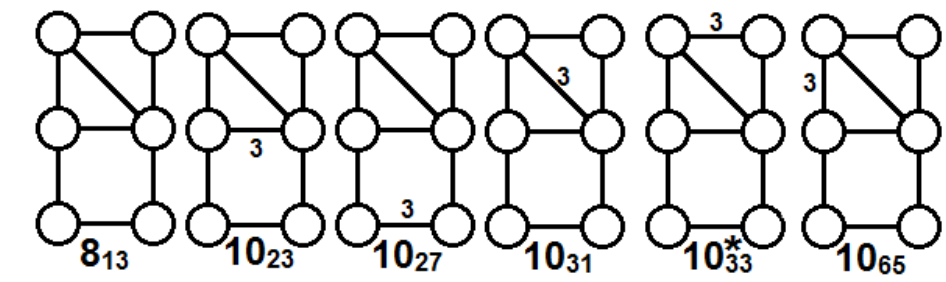

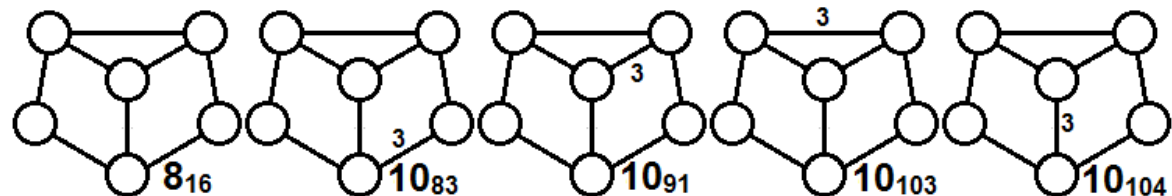
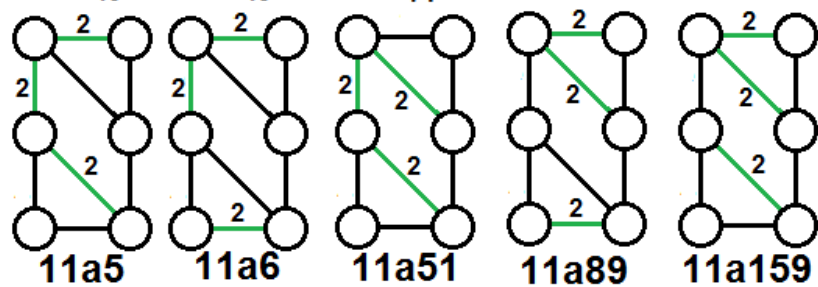
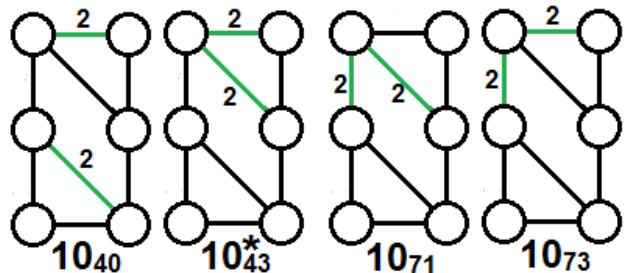
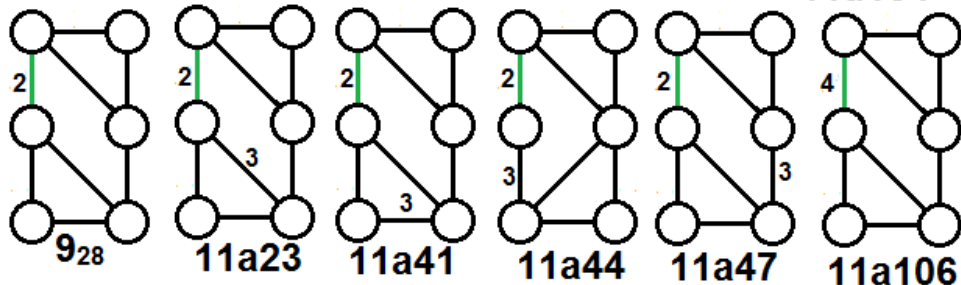
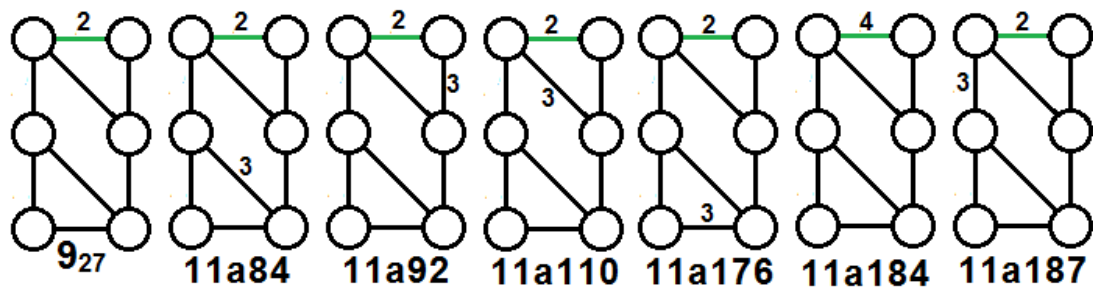
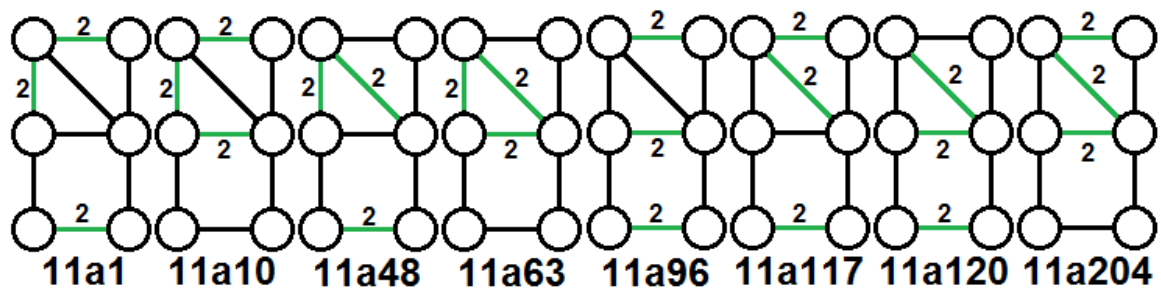

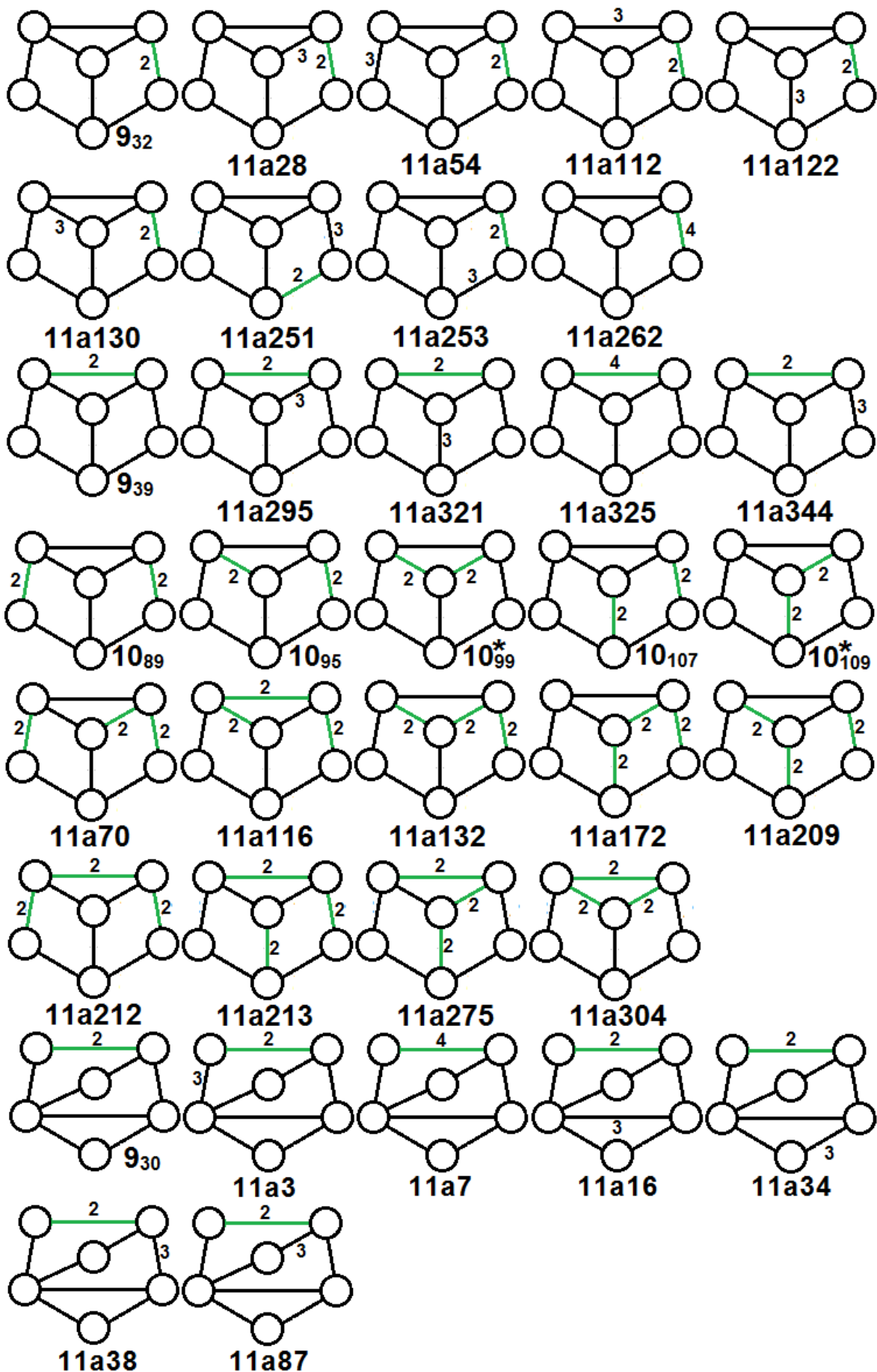



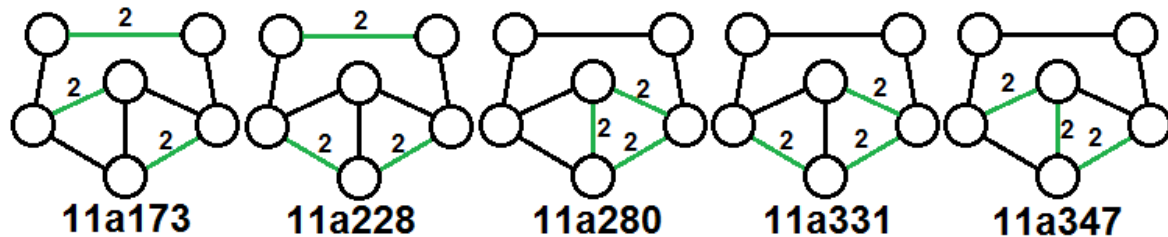
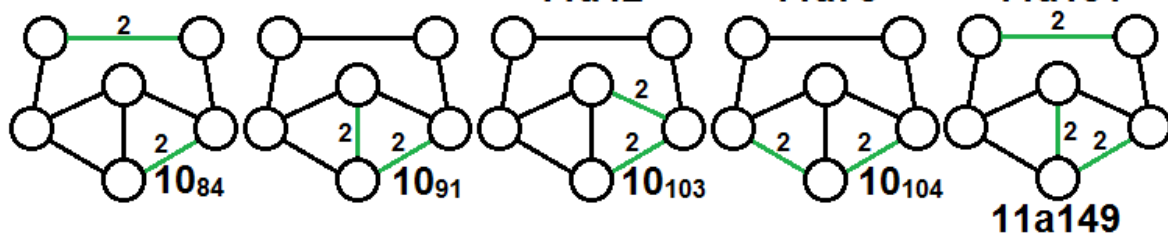
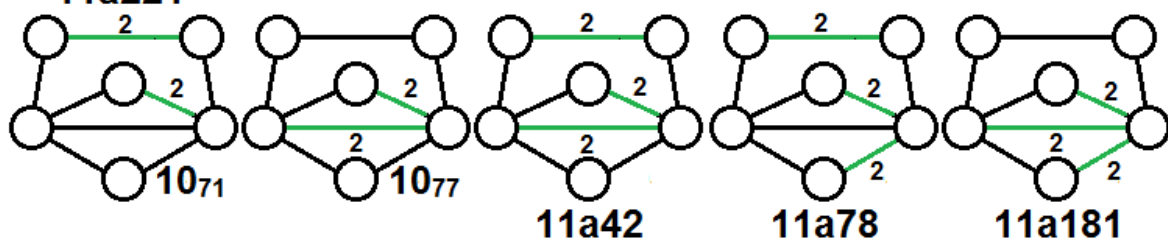
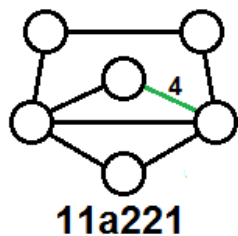
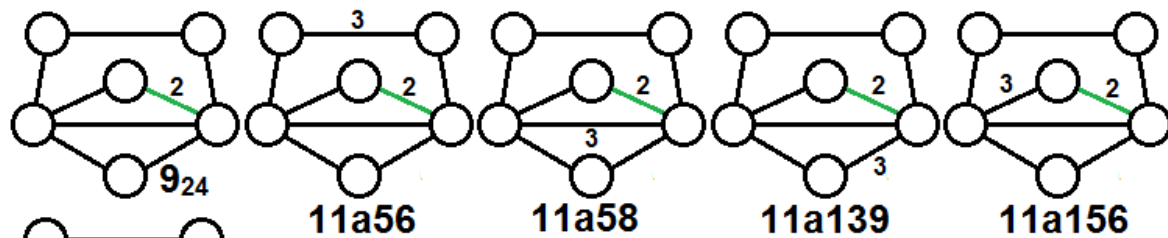
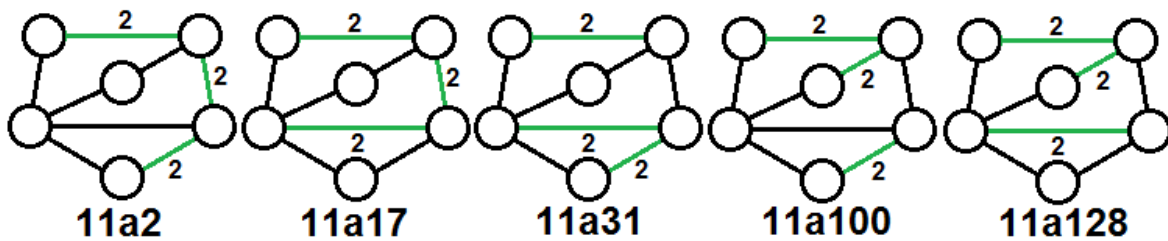
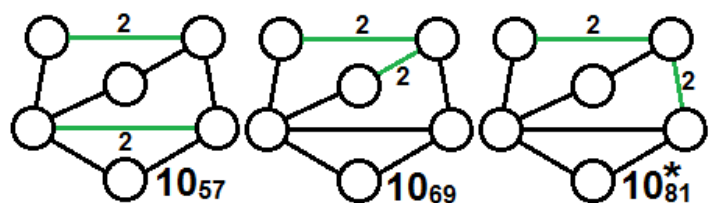

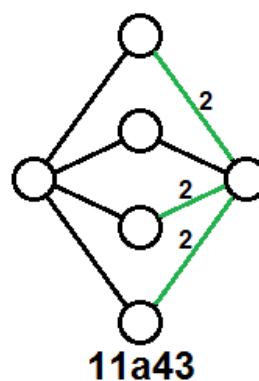
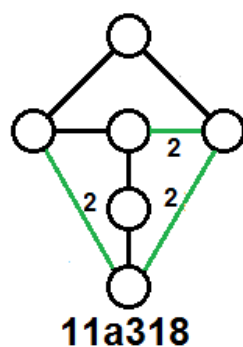
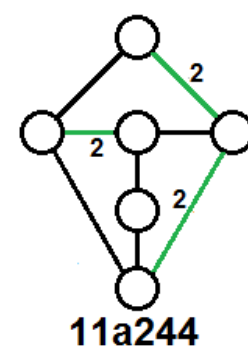
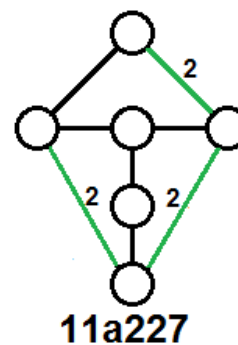
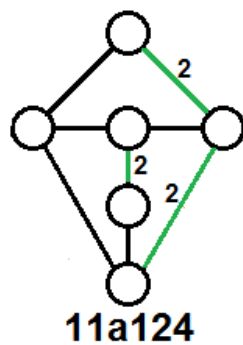
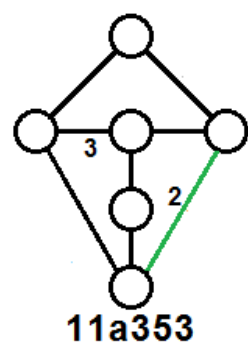
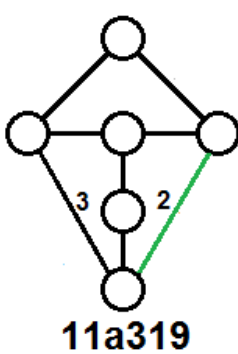
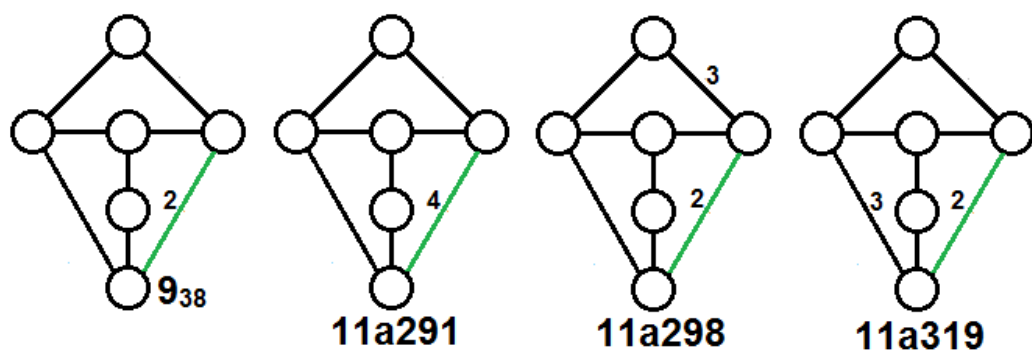

**6:9**

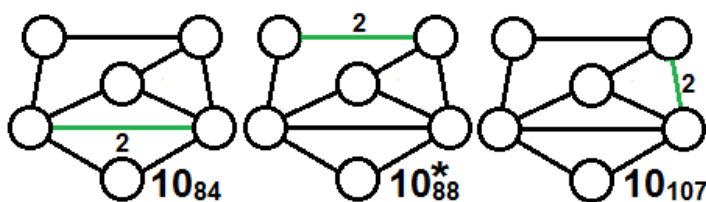
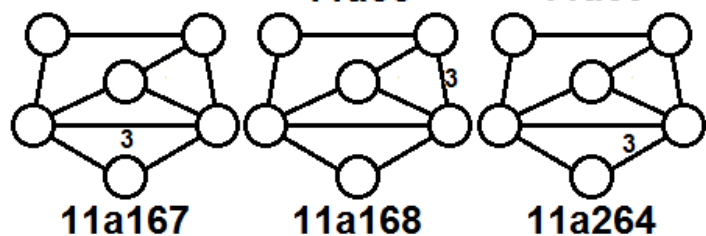
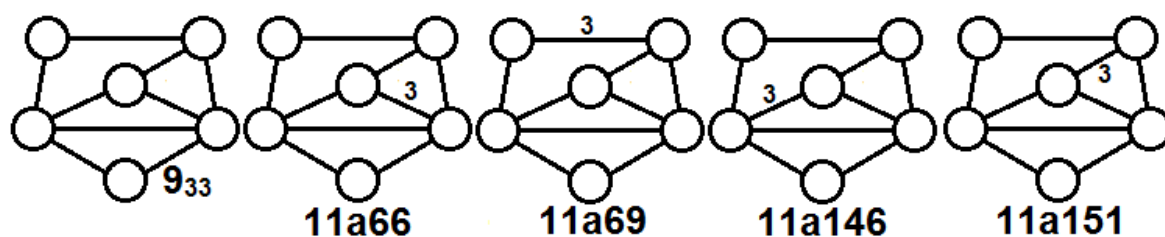

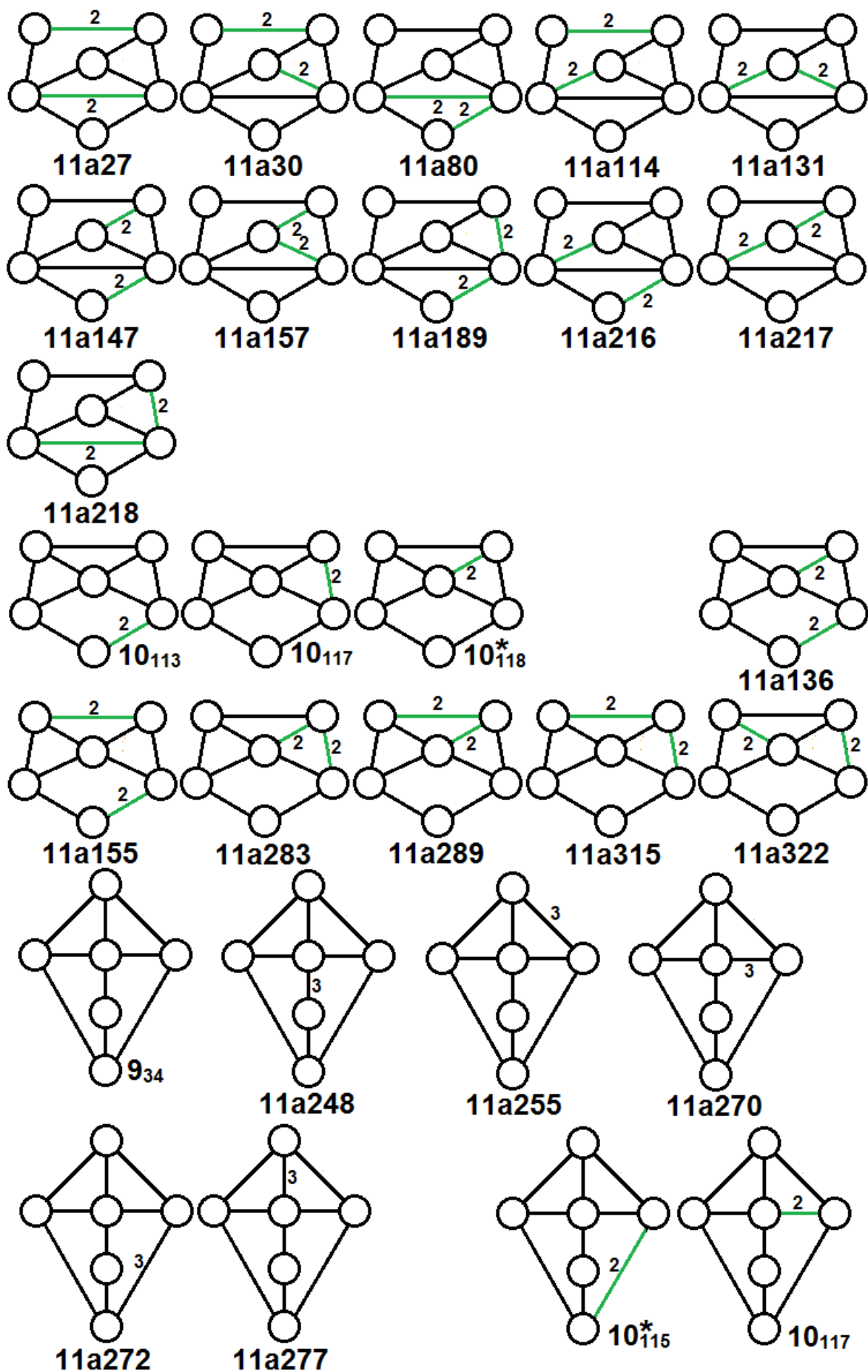

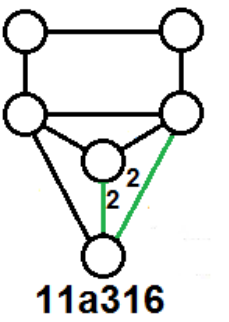
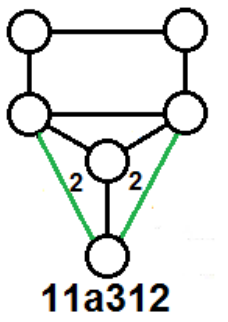
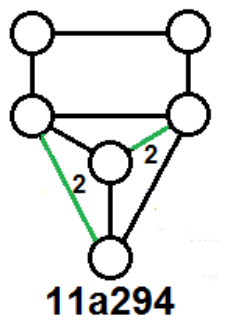
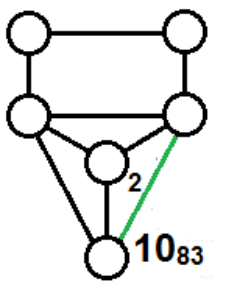
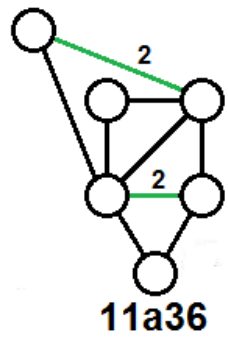
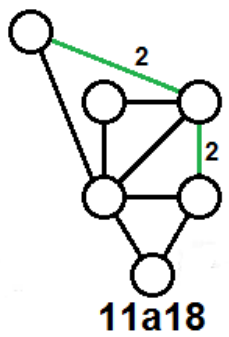
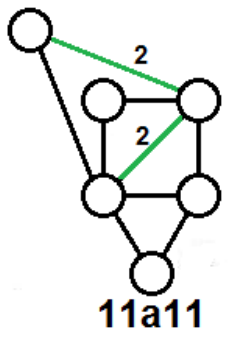
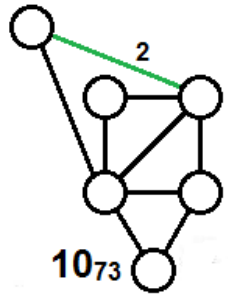
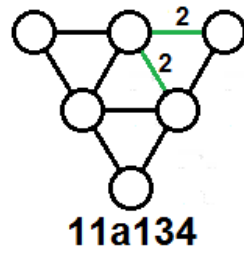
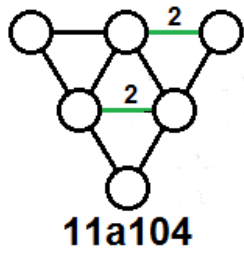
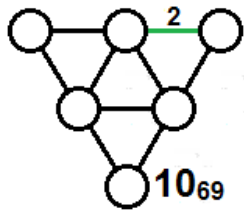
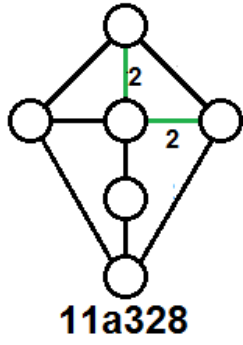
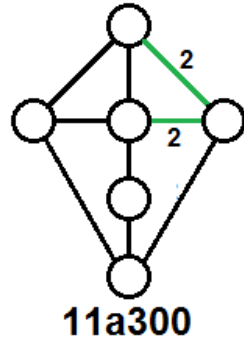
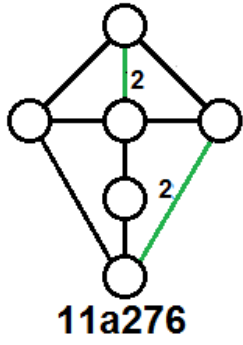
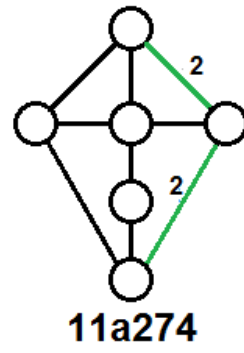
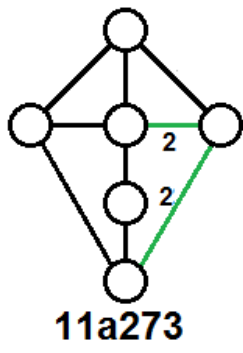
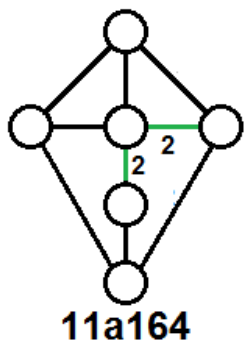
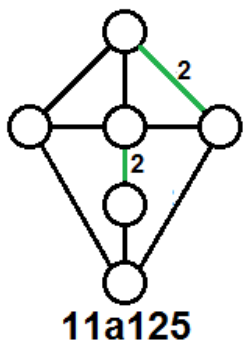

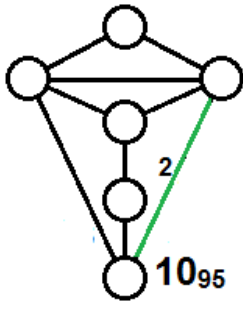

10<sub>95</sub>

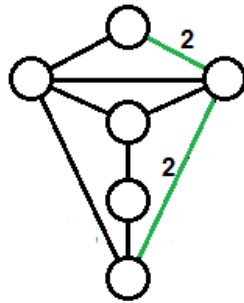

11a<sub>76</sub>

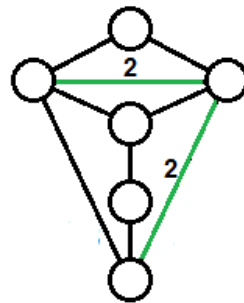

11a<sub>150</sub>

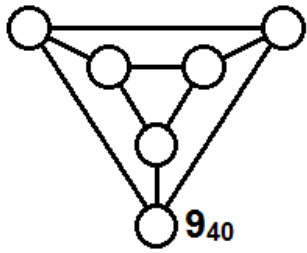

9<sub>40</sub>

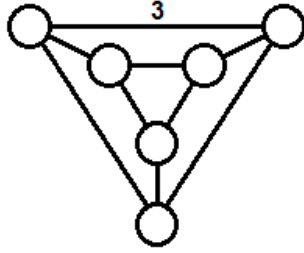

11a<sub>349</sub>

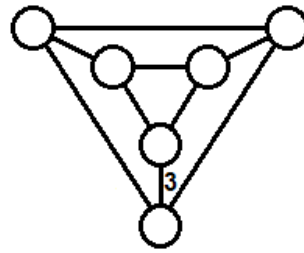

11a<sub>351</sub>

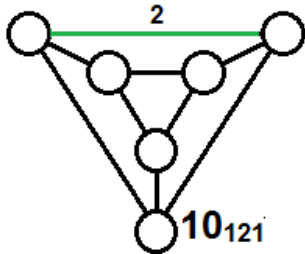

10<sub>121</sub>

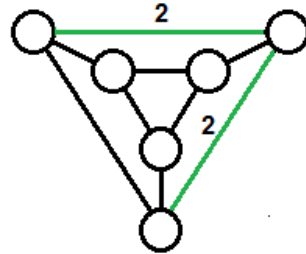

11a<sub>271</sub>

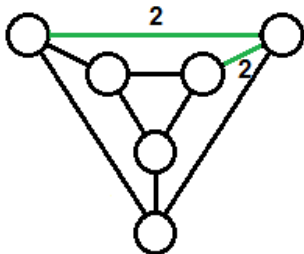

11a<sub>287</sub>

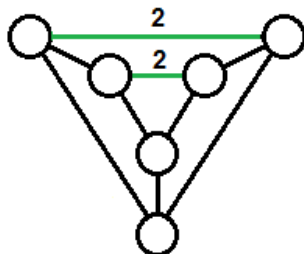

11a<sub>297</sub>

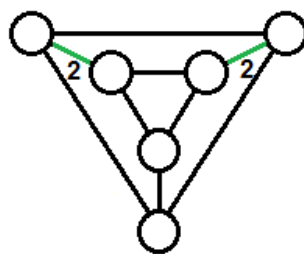

11a<sub>332</sub>

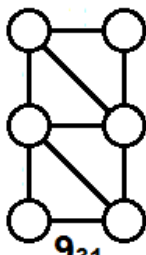

9<sub>31</sub>

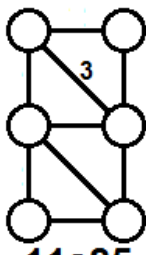

11a<sub>85</sub>

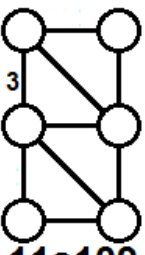

11a<sub>109</sub>

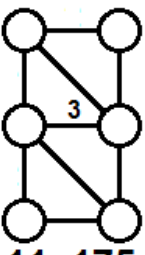

11a<sub>175</sub>

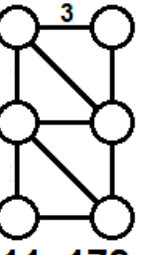

11a<sub>178</sub>

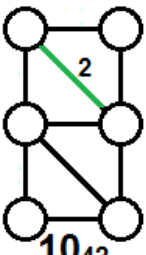

10<sub>42</sub>

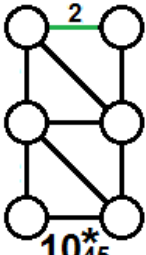

10\*<sub>45</sub>

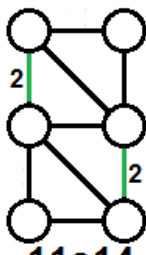

11a<sub>14</sub>

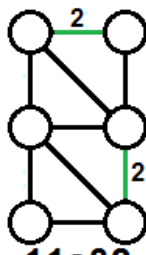

11a<sub>32</sub>

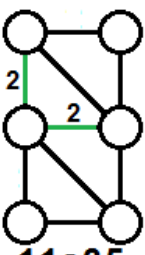

11a<sub>35</sub>

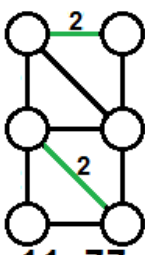

11a<sub>77</sub>

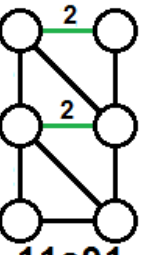

11a<sub>91</sub>

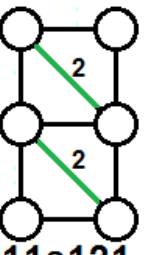

11a<sub>121</sub>

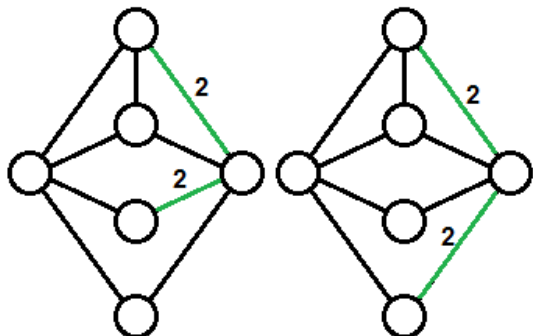

11a19

11a25

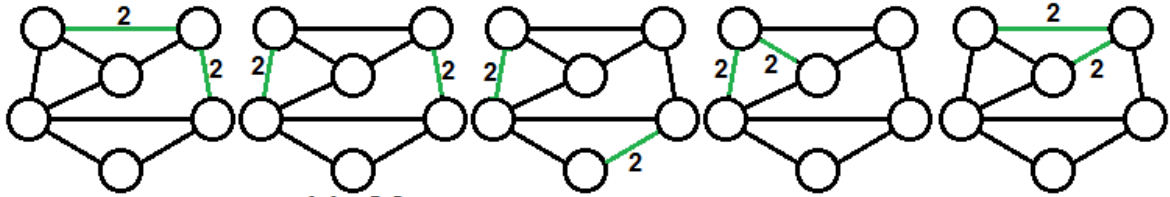

11a24

11a26

11a71

11a79

11a160

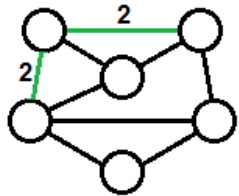

11a196

6:10

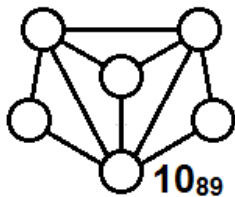

10<sub>89</sub>

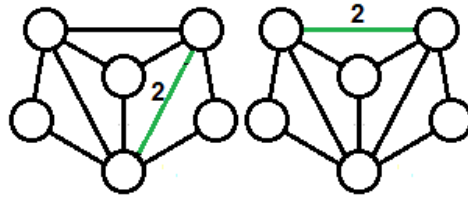

11a52

11a197

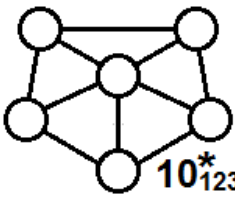

10\*<sub>123</sub>

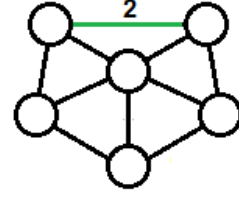

11a327

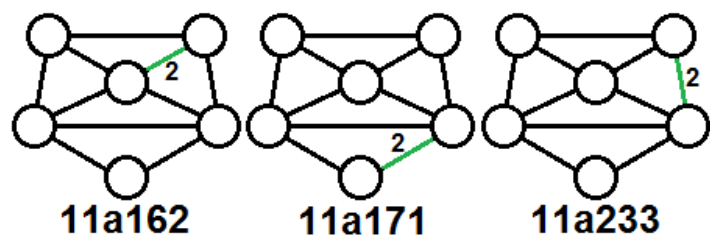
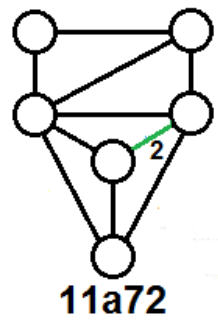
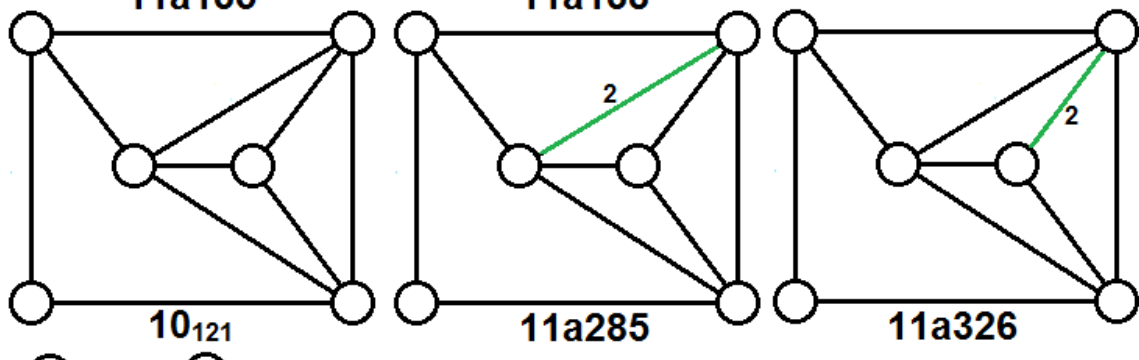
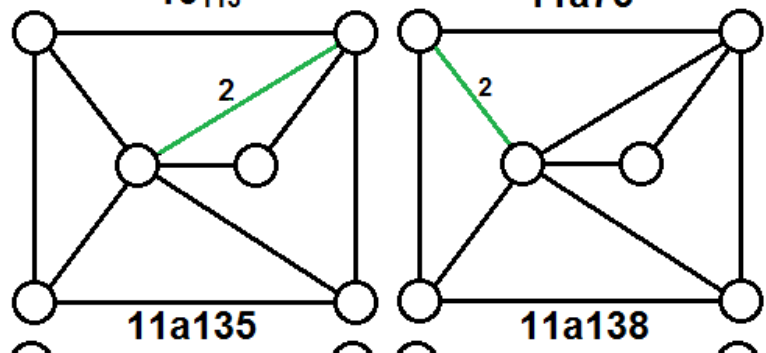
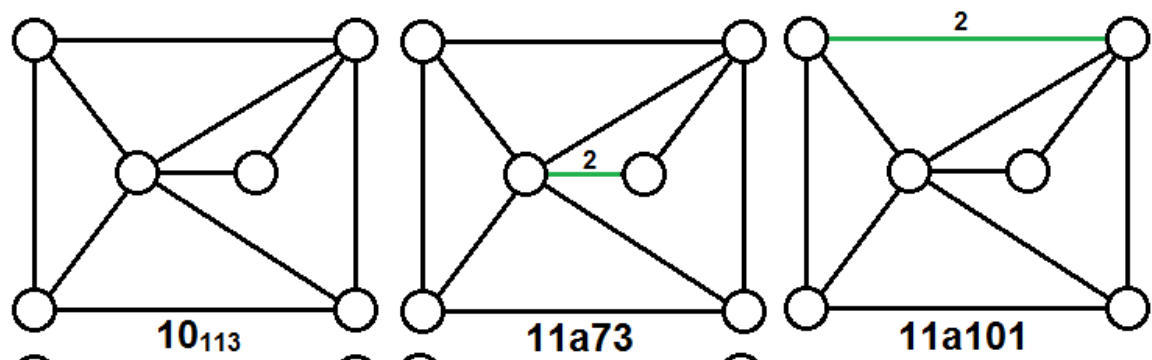

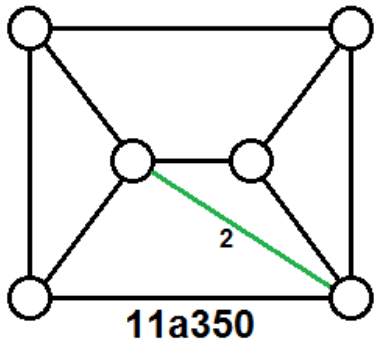
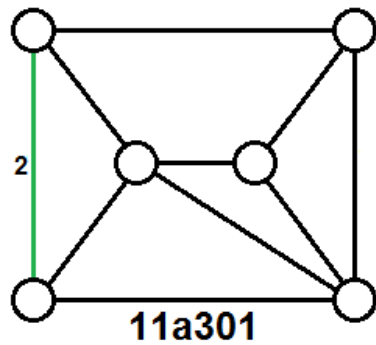
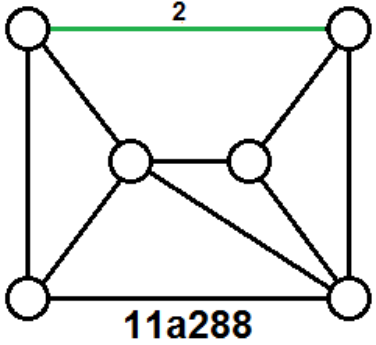
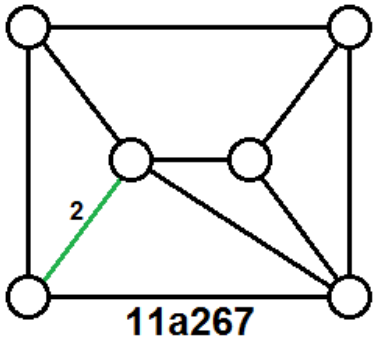
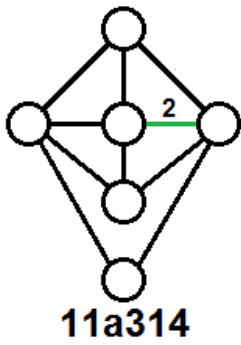
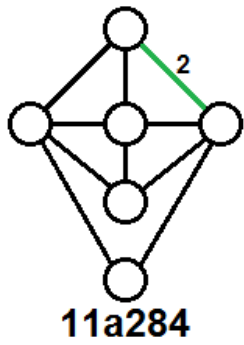
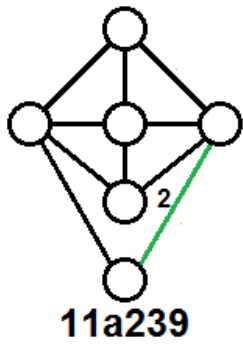
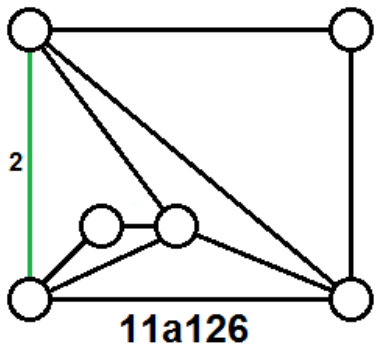

**6:11**

